

18-2648

**United States Court of Appeals
for the Third Circuit**

CITY OF PHILADELPHIA,

Plaintiff-Appellee,

v.

ATTORNEY GENERAL OF THE UNITED STATES,

Defendant-Appellant.

On Appeal from the United States District Court
for the Eastern District of Pennsylvania

**BRIEF FOR AMICUS CURIAE STATES OF NEW YORK,
CALIFORNIA, CONNECTICUT, DELAWARE, ILLINOIS, IOWA,
MARYLAND, MASSACHUSETTS, NEW JERSEY, NEW MEXICO,
OREGON, RHODE ISLAND, VERMONT, AND WASHINGTON, AND
THE DISTRICT OF COLUMBIA IN SUPPORT OF APPELLEE**

ANISHA S. DASGUPTA
Deputy Solicitor General

LINDA FANG
Assistant Solicitor General

ERIC R. HAREN
*Special Counsel and Assistant
Solicitor General
of Counsel*

BARBARA D. UNDERWOOD
*Attorney General
State of New York*
28 Liberty Street
New York, NY 10005
(212) 416-8656

Dated: October 11, 2018

(Counsel listing continues on signature pages.)

TABLE OF CONTENTS

	Page
TABLE OF AUTHORITIES.....	ii
INTRODUCTION AND INTERESTS OF AMICI.....	1
FACTUAL BACKGROUND.....	3
A. The Byrne JAG Formula Grant.....	3
B. The Immigration-Related Conditions.....	6
ARGUMENT	
THE DISTRICT COURT CORRECTLY HELD THAT THE CHALLENGED CONDITIONS ARE UNLAWFUL.....	9
A. The Byrne JAG Statute Does Not Permit the U.S. Attorney General to Impose New Eligibility Requirements on Byrne JAG Grant Recipients.	9
B. The Challenged Conditions Are Not Authorized by 34 U.S.C. § 10102(a)(6).	14
C. The § 1373 Requirement Is Not Authorized by 34 U.S.C. § 10153(a)(5)(D).....	20
D. Section 1373 Violates the Tenth Amendment.....	25
E. The Challenged Conditions Are Inconsistent with 34 U.S.C. § 10228(a) Because They Seek to Direct and Control the Actions of State and Local Law Enforcement.....	28
CONCLUSION.....	32

TABLE OF AUTHORITIES

Cases	Page(s)
<i>Ali v. Federal Bureau of Prisons</i> , 552 U.S. 214 (2008).....	29
<i>City and County of San Francisco v. Sessions</i> , No. 17-cv-4642, 2018 WL 4859528 (N.D. Cal. Oct. 5, 2018)	passim
<i>City of Chicago v. Sessions</i> , 264 F. Supp. 3d 933 (N.D. Ill. 2017)	passim
<i>City of Chicago v. Sessions</i> , 321 F. Supp. 3d 855 (N.D. Ill. 2018).....	8, 20, 26, 28
<i>City of Chicago v. Sessions</i> , 888 F.3d 272 (7th Cir. 2018).....	passim
<i>City of Los Angeles v. McLaughlin</i> , 865 F.2d 1084 (9th Cir. 1989).....	9-10
<i>City of Philadelphia v. Sessions</i> , 280 F. Supp. 3d 579 (E.D. Pa. 2017).....	passim
<i>Department of Homeland Sec. v. MacLean</i> , 135 S. Ct. 913 (2015).....	10
<i>Ely v. Velde</i> , 451 F.2d 1130 (4th Cir. 1971).....	30
<i>Food & Drug Admin. v. Brown & Williamson Tobacco Corp.</i> , 529 U.S. 120 (2000).....	13
<i>Griffin v. Oceanic Contractors, Inc.</i> , 458 U.S. 564 (1982).....	24
<i>Louisiana Pub. Serv. Comm’n v. FCC</i> , 476 U.S. 355 (1986).....	9

Cases	Page(s)
<i>McDermott Int’l, Inc. v. Wilander</i> , 498 U.S. 337 (1991).....	17, 23
<i>Murphy v. National Collegiate Athletic Ass’n</i> , 138 S. Ct. 1461 (2018).....	25, 26, 27, 28
<i>Printz v. United States</i> , 521 U.S. 898 (1997).....	30, 31
<i>United States v. California</i> , 314 F. Supp. 3d 1077 (E.D. Cal. 2018)	26
 Laws	
Anti-Drug Abuse Act of 1988, Pub. L. No. 100-690, 102 Stat. 4181	4
Justice Assistance Act of 1984, Pub. L. No. 98-473, 98 Stat. 1837	3-4
Justice System Improvement Act of 1979, Pub. L. No. 96- 157, 93 Stat. 1167	3, 22
Omnibus Crime Control and Safe Streets Act of 1968, Pub. L. No. 90-351, 82 Stat. 197	3, 4, 29
Violence Against Women and Department of Justice Reauthorization Act of 2005, Pub. L. No. 109-162 119 Stat. 2960 (2006)	4
8 U.S.C. § 1373	passim
34 U.S.C.	
§ 10102	14
§§ 10151-58	5, 11
§ 10151 <i>et seq.</i>	1
§ 10152	5, 6, 19
§ 10153	19, 21
§ 10156	6, 9, 19

Laws	Page(s)
34 U.S.C. (<i>cont'd</i>)	
§ 10157	10
§§ 10171-91	11
§ 10228	5, 12, 28
§ 10410	1
§ 20927	11
§ 30307	11
42 U.S.C.	
§ 2000d	21
§ 3756 (2000)	11
2 C.F.R. § 200.207	17, 18
28 C.F.R. § 66.12 (2006)	16, 17, 18
53 Fed. Reg. 8,034 (Mar. 11, 1988)	15
79 Fed. Reg. 75,872 (Dec. 19, 2014)	16
Legislative History	
H.R. Rep. No. 103-694 (1994) (Conf. Report).....	12
H.R. Rep. No. 109-233 (2005).....	5, 12
S. Rep. No. 90-1097 (1968).....	4, 29
<i>Amendments to Title I (LEAA) of the Omnibus Crime Control and Safe Streets Act: Hearing Before the Subcomm. on Criminal Laws and Procedures of the S. Judiciary Comm., 94th Cong. (1976).....</i>	23
<i>Controlling Crime Through More Effective Law Enforcement: Hearings Before the Subcomm. on Criminal Laws and Procedure of the S. Comm. on the Judiciary, 90th Cong. (1967).....</i>	30

Legislative History	Page(s)
Enforce the Law for Sanctuary Cities Act, H.R. 3009, 114th Cong. (2015)	12
<i>Federal Assistance to State and Local Criminal Justice Agencies: Hearing Before the Subcomm. on Criminal Laws and Procedures of the S. Comm. on the Judiciary, 95th Cong. (1978)</i>	<i>24</i>
Mobilizing Against Sanctuary Cities Act, H.R. 3002, 114th Cong. (2015)	12
<i>Restructuring the Law Enforcement Assistance Administration: Hearings Before the Subcomm. on Crime of the H. Comm. on the Judiciary, 95th Cong. (1977).....</i>	<i>24</i>
Stop Dangerous Sanctuary Cities Act, H.R. 5654, 114th Cong. (2016)	12
Stop Dangerous Sanctuary Cities Act, S. 3100, 114th Cong. (2016)	12
Stop Sanctuary Cities Act, S. 1814, 114th Cong. (2015)	13
Stop Sanctuary Policies and Protect Americans Act, S. 2146, 114th Cong. (2015).....	12-13
Violent Crime Control and Law Enforcement Act of 1994 H.R. 3355, 103d Cong. (version dated Nov. 19, 1993).....	12
 Miscellaneous Authorities	
Dep’t of Justice, Certified Standard Assurances (exp. May 31, 2019), at https://ojp.gov/funding/Apply/Resources/ StandardAssurances.pdf	21
Dep’t of Justice, Law Enforcement Assistance Admin., <i>General Briefing</i> (1977).....	22

Miscellaneous Authorities	Page(s)
Dep't of Justice, Office of Justice Programs, <i>Byrne JAG Program: FY 2018 State Solicitation</i> , at https://www.bja.gov/funding/JAGState18.pdf	8, 19
Dep't of Justice, <i>Restructuring the Justice Department's Program of Assistance to State and Local Governments for Crime Control and Criminal Justice System Improvement</i> (June 23, 1977).....	23, 25
John K. Hudzik et al., <i>Federal Aid to Criminal Justice: Rhetoric, Results, Lessons</i> (1984).....	29
Malcolm S. Mason, <i>Monitoring of Grantee Performance</i> , in <i>Federal Grant Law</i> (Malcolm S. Mason ed., 1982).....	15
Office of Representative Peter W. Rodino, Press Release, <i>Committee Approves LEAA Reorganization</i> (May 10, 1979).....	24
Paul G. Dembling & Malcom S. Mason, <i>Essentials of Grant Law Practice</i> (1991)	9, 15

INTRODUCTION AND INTERESTS OF AMICI

The Edward Byrne Memorial Justice Assistance Grant (Byrne JAG) program is a formula grant program that Congress designed to ensure that States and localities have a reliable stream of funding to support local law-enforcement programs tailored to local needs. *See* 34 U.S.C. § 10151 *et seq.* The amici States of New York, California, Connecticut, Delaware, Illinois, Iowa, Maryland, Massachusetts, New Jersey, New Mexico, Oregon, Rhode Island, Vermont, Washington, and the District of Columbia have received law-enforcement grants under the Byrne JAG program and its predecessors for decades.¹ Amici have used the funds to support a diverse array of law-enforcement programs tailored to local needs. For example, New York has used Byrne JAG funding to support a multicounty program to combat gun violence, improve criminal records systems, and enhance forensic laboratories. Connecticut plans to use fiscal year (FY) 2017 Byrne JAG funds to reduce recidivism, prevent gun violence, provide training to mentally ill offenders, and provide treatment for offenders addicted to opioids and

¹ The District of Columbia is considered a “state” for purposes of the Byrne JAG program. *See* 34 U.S.C. § 10410(3).

heroin. New Jersey has historically used Byrne JAG funding to support multi-jurisdictional gang, gun, and narcotics task forces and law-enforcement information-sharing projects. And the District of Columbia will use its FY 2017 Byrne JAG grant to fund efforts by community-based organizations to provide re-entry services to help individuals transition from jail or prison back into the community, and to address juvenile delinquency. Without Byrne JAG funds, the amici States may be forced to cut these critical programs.

The U.S. Attorney General now wrongly claims authority to withhold Byrne JAG funding from States and localities that have chosen to limit their voluntary involvement with enforcing federal immigration policy because they have concluded that fostering a relationship of trust between their law-enforcement officials and their immigrant communities will promote public safety. The U.S. Attorney General's position is contrary to the text, structure, and history of the Byrne JAG statute and to federal law generally prohibiting federal officials from using grants as a means to direct or control local law-enforcement activities.

The amici States have adopted a variety of different approaches to cooperating with the federal government in immigration matters. While

they may not all have chosen precisely the same approach as the City of Philadelphia, they share a strong interest in the principle that Philadelphia, like all State and local governments, is permitted by the Byrne JAG statute to adopt law-enforcement policies suited to local needs without financial penalty.²

FACTUAL BACKGROUND

A. The Byrne JAG Formula Grant

The Byrne JAG program has its origins in the Omnibus Crime Control and Safe Streets Act of 1968, Pub. L. No. 90-351, Title I, 82 Stat. 197, which created the first block grants for States and localities to use for law-enforcement and criminal justice programs.³ Recognizing that

² Several of the amici States and a number of localities have filed their own lawsuits challenging the Byrne JAG conditions. *See* Amended Compl., *New York v. DOJ*, No. 18-cv-6471 (S.D.N.Y. Aug. 6, 2018), ECF No. 32 (joined by Connecticut, Massachusetts, New Jersey, Rhode Island, Virginia, and Washington); Compl., *Illinois v. Sessions*, No. 18-cv-4791 (N.D. Ill. July 12, 2018), ECF No. 1; Compl., *City of Evanston v. Sessions*, No. 18-cv-4853 (N.D. Ill. July 16, 2018), ECF No. 1 (joined by the U.S. Conference of Mayors, representing approximately 1,400 cities); Compl., *City of New York v. Sessions*, No. 18-cv-6474 (S.D.N.Y. July 18, 2018), ECF No. 1.

³ *See* Justice System Improvement Act of 1979, Pub. L. No. 96-157, 93 Stat. 1167, 1179 (amending Title I of the 1968 Act and reauthorizing law-enforcement block grants to States and localities); Justice Assistance Act

“crime is essentially a local problem that must be dealt with by State and local governments,” 82 Stat. at 197, Congress designed the grant to provide a reliable funding stream that States and localities could use in accordance with state and local law-enforcement policies, and for state and local law-enforcement purposes.⁴

To ensure federal deference to local priorities, Congress expressly prohibited federal agencies and executive-branch officials from using the Byrne JAG grant—and other law-enforcement grants administered by the U.S. Department of Justice (DOJ)—to “exercise any direction, supervision, or control over any police force or any other law enforcement agency of any State or any political subdivision thereof.” Pub. L. No. 90-351, § 518(a), 82 Stat. at 208. Although Congress has repeatedly modified

of 1984, Pub. L. No. 98-473, 98 Stat. 1837, 2077-85 (same); Anti-Drug Abuse Act of 1988, Pub. L. No. 100-690, pt. E, 102 Stat. 4181, 4329 (amending Title I of the 1968 Act and creating formula law-enforcement grant); Violence Against Women and Department of Justice Reauthorization Act of 2005, Pub. L. No. 109-162, § 1111, 119 Stat. 2960, 3094 (2006) (amending Title I of the 1968 Act and creating the modern Byrne JAG program).

⁴ See S. Rep. No. 90-1097, at 2 (1968) (stating that Congress sought to encourage States and localities to adopt programs “based upon their evaluation of State and local problems of law enforcement”). (Excerpt in Addendum (Add.) to this brief at 2.)

the structure and terms of the law-enforcement grants authorized under Title I of the 1968 Act, the prohibition originally set forth in § 518 of the 1968 Act remains in effect with virtually no modification, and is now codified in the same chapter of the *United States Code* as Byrne JAG. *See* 34 U.S.C. § 10228(a).⁵

The modern Byrne JAG program was codified in 2006. *See id.* §§ 10151-58. Like its predecessors, Byrne JAG aims to “give State and local governments more flexibility to spend money for programs that work for them rather than to impose a ‘one size fits all’ solution.” H.R. Rep. No. 109-233, at 89 (2005). To that end, the statute creates a mandatory formula grant and gives recipients substantial discretion to use funds for eight “broad purposes,” *id.*, including law enforcement, crime prevention and education, and drug treatment, 34 U.S.C. § 10152(a)(1).

⁵ The full text of § 10228(a) reads:

Nothing in this chapter or any other Act shall be construed to authorize any department, agency, officer, or employee of the United States to exercise any direction, supervision, or control over any police force or any other criminal justice agency of any State or any political subdivision thereof.

The Byrne JAG program is administered by DOJ through its Office of Justice Programs (OJP), which is required to issue grants “in accordance with the formula” set forth in the Byrne JAG statute, *id.* Specifically, “[o]f the total amount appropriated” by Congress, the U.S. Attorney General “shall, except as provided in paragraph (2), allocate” fifty percent of the funds based on each State’s population and fifty percent based on each State’s crime rate. *Id.* § 10156(a)(1). The exception in paragraph (2) provides that each State must receive at least one-quarter of one percent of the funds appropriated by Congress for a given year, regardless of what the formula would otherwise dictate. *Id.* § 10156(a)(2). In each State, sixty percent of funding “shall be for direct grants to States,” *id.* § 10156(b)(1), and forty percent “shall be for grants” directly to localities (compared within a State based on crime rate), *id.* § 10156(b)(2), (d).

B. The Immigration-Related Conditions

In July 2017, DOJ announced that it was imposing three immigration-related conditions on FY 2017 Byrne JAG funds. The first two conditions require grant recipients, upon a request from federal authorities, to provide federal authorities with advance notice of a

particular alien's scheduled date of release from state and local custody (the "Notice condition"), and to give federal authorities access to state and local correctional facilities to question suspected aliens about their right to remain in the United States (the "Access condition"). The third condition imposes a number of requirements relating to 8 U.S.C. § 1373, which prohibits States and localities from restricting communications between their officials and federal immigration authorities regarding the citizenship or immigration status of any individual. Among other things, the § 1373 condition provides that States and localities must certify their compliance with § 1373, and monitor the compliance of all of their subgrantees with § 1373 during the duration of a Byrne JAG award.

On September 15, 2017, the U.S. District Court for the Northern District of Illinois entered a preliminary injunction restraining DOJ from imposing the Notice and Access conditions on any grant applicant. *See City of Chicago v. Sessions*, 264 F. Supp. 3d 933 (N.D. Ill. 2017), *aff'd*, 888 F.3d 272 (7th Cir. 2018). On June 26, 2018, the U.S. Court of Appeals for the Seventh Circuit issued a partial stay of the preliminary injunction, limiting its effect to Chicago. *See Order, City of Chicago v. Sessions*, No. 17-2991 (7th Cir. June 26, 2018), ECF No. 134. Within hours of that

decision, DOJ issued Byrne JAG award letters containing the three immigration-related conditions to over 800 jurisdictions nationwide, including some but not all of the amici States.⁶

On July 20, 2018, DOJ released solicitations for FY 2018 Byrne JAG funding.⁷ In addition to imposing the Notice, Access, and § 1373 requirements, DOJ is now requiring grantees to execute certifications pertaining to six additional federal immigration laws in order to receive FY 2018 grants.

⁶ On August 15, 2018, the *Chicago* district court entered a permanent nationwide injunction prohibiting DOJ from enforcing any of the three challenged conditions against any Byrne JAG grantee, but partly stayed the permanent injunction to limit its effect to Chicago. *See City of Chicago v. Sessions*, No. 17-cv-5720 (N.D. Ill. Aug. 15, 2018), ECF No. 211; *City of Chicago v. Sessions*, 321 F. Supp. 3d 855, 882 (N.D. Ill. 2018). Subsequently, the district court in the Northern District of California in *City and County of San Francisco v. Sessions* and *California v. Sessions* entered a similar nationwide permanent injunction against the challenged conditions, and likewise partly stayed the injunction pending appellate review, limiting the injunction's effect to San Francisco and California. *See* Nos. 17-cv-4642 and 17-cv-4701, 2018 WL 4859528 (N.D. Cal. Oct. 5, 2018) ("*California Actions*").

⁷ *See* DOJ, Office of Justice Programs, *Byrne JAG Program: FY 2018 State Solicitation*.

ARGUMENT

THE DISTRICT COURT CORRECTLY HELD THAT THE CHALLENGED CONDITIONS ARE UNLAWFUL

A. **The Byrne JAG Statute Does Not Permit the U.S. Attorney General to Impose New Eligibility Requirements on Byrne JAG Grant Recipients.**

Under basic separation-of-powers principles, an executive “agency literally has no power to act . . . unless and until Congress confers power upon it.” *Louisiana Pub. Serv. Comm’n v. FCC*, 476 U.S. 355, 374 (1986). Here, the Byrne JAG statute contains no express provision authorizing DOJ to impose new eligibility requirements that are unrelated to federal grant-making or to the Byrne JAG program requirements prescribed by Congress. The statute instead provides that “the Attorney General shall . . . allocate” grant money based on the statutory formula. 34 U.S.C. § 10156(a)(1). Consistent with the nature of Byrne JAG as a formula grant, the statutory formula is determinative of a grantee’s eligibility to receive grant funds.⁸ *See City of Los Angeles v. McLaughlin*, 865 F.2d

⁸ *See* Paul G. Dembling & Malcom S. Mason, *Essentials of Grant Law Practice* § 5.03(c), at 34-35 (1991) (the General Accounting Office defines “formula grant” as “grants in which a structured mathematical statement and data elements, such a statistical data, are used to (1)

1084, 1088 (9th Cir. 1989).

Other provisions of Byrne JAG confirm that Congress intended to constrain DOJ's ability to deviate from the statutory formula when disbursing grants. For example, 34 U.S.C. § 10157(b) permits DOJ to reserve up to five percent of appropriated funds and reallocate them to a State or locality if DOJ determines that reallocation is necessary to combat "extraordinary increases in crime" or to "mitigate significant programmatic harm resulting from" the formula. By expressly restricting DOJ's authority to redirect Byrne JAG funds to very limited and specifically enumerated instances—none of which are implicated here—Congress made clear that DOJ must otherwise abide by the statutory formula in distributing grant monies. *See, e.g., Department of Homeland Sec. v. MacLean*, 135 S. Ct. 913, 919 (2015) (provision of express authority in one statutory section implies intent to exclude such authority elsewhere).

The structure of title 34, chapter 101 of the *United States Code* underscores these limits on DOJ's authority. Byrne JAG is located in part A of subchapter V of Chapter 101, which is entitled "Edward Byrne

allocate funds to eligible recipients, or (2) determine a potential grant recipient's eligibility to receive funds, or both.") (Add. 110-111.)

Memorial Justice Assistance Grant Program.” *See* 34 U.S.C. §§ 10151-58. In contrast, Part B, entitled “Discretionary Grants,” authorizes DOJ to issue grants to support projects similar to those supported by Byrne JAG but at DOJ’s discretion. *See id.* §§ 10171-91.

Where Congress has sought to condition Byrne JAG funds upon compliance with other legislative aims, it has done so explicitly by statute—and in such cases has authorized only modest withholdings. For example, a State that fails to “substantially implement” relevant provisions of the Sex Offender Registration and Notification Act “shall not receive 10 percent of the funds” it would otherwise receive under Byrne JAG. *See id.* § 20927(a).⁹ The amici States are unaware of Congress ever imposing a condition on Byrne JAG that would withhold *all* funding as DOJ now seeks to do.

The Byrne JAG statute’s legislative history leads to the same conclusion. When Congress created the first predecessor to the Byrne JAG program in 1968, it also enacted a statute to ensure that grants

⁹ *See also* 34 U.S.C. § 30307(e)(2) (providing a five-percent penalty for noncompliance with the Prison Rape Elimination Act); 42 U.S.C. § 3756(f) (2000) (providing a ten-percent penalty for not testing sex offenders for HIV at victims’ request).

under that predecessor program would not become a means for federal agencies to control, direct, or supervise state and local law enforcement. See *infra* at 28-30; 34 U.S.C. § 10228(a). In addition, when enacting Byrne JAG—the latest version of the 1968 program (see *supra* at 3-5)—Congress reaffirmed its aim to “give State and local governments more flexibility to spend money for programs that work for them rather than to impose a ‘one size fits all’ solution.” H.R. Rep. No. 109-233, at 89.

Since the 1990s, Congress has repeatedly considered and rejected legislation that would withhold grant funding as a penalty for noncooperation with federal immigration law. For example, the Senate version of the 1994 Crime Bill included such a provision, but it was eliminated in conference. See Violent Crime Control and Law Enforcement Act of 1994 H.R. 3355, 103d Cong. § 5119 (version dated Nov. 19, 1993); H.R. Rep. No. 103-694, at 424 (1994) (Conf. Report). More recent attempts to impose similar restrictions have uniformly failed.¹⁰ In light

¹⁰ See, e.g., Stop Dangerous Sanctuary Cities Act, H.R. 5654, 114th Cong. § 4 (2016); Stop Dangerous Sanctuary Cities Act, S. 3100, 114th Cong. § 4 (2016); Enforce the Law for Sanctuary Cities Act, H.R. 3009, 114th Cong. § 3 (2015); Mobilizing Against Sanctuary Cities Act, H.R. 3002, 114th Cong. § 2 (2015); Stop Sanctuary Policies and Protect

of Congress's repeated failure to enact legislation imposing similar immigration-related conditions on grants, DOJ's current attempt to do so is suspect. *See Food & Drug Admin. v. Brown & Williamson Tobacco Corp.*, 529 U.S. 120, 159-60 (2000).

As the Seventh Circuit has recognized, nothing in the Byrne JAG statute "grant[s] the Attorney General the authority to impose conditions that require states or local governments to assist in immigration enforcement, nor to deny funds to states or local governments for the failure to comply with those conditions." *Chicago*, 888 F.3d at 284; *see also California Actions*, 2018 WL 4859528, at *11-13. The district court here correctly reached this same conclusion. *See City of Philadelphia v. Sessions*, 280 F. Supp. 3d 579, 593-94 (E.D. Pa. 2017), *appeal dismissed*, 2018 WL 347591 (3d Cir. July 6, 2018).

Americans Act, S. 2146, 114th Cong. § 3(a) (2015); Stop Sanctuary Cities Act, S. 1814, 114th Cong. § 2 (2015).

B. The Challenged Conditions Are Not Authorized by 34 U.S.C. § 10102(a)(6).

Contrary to DOJ's contention (Br. for Appellant (Br.) at 26-29), the language in 34 U.S.C. § 10102(a)(6) does not authorize DOJ to impose its own criteria for determining Byrne JAG eligibility. That provision instead authorizes the Assistant Attorney General who is the head of OJP to "exercise such other powers and functions as may be vested in the Assistant Attorney General *pursuant to this chapter* or by delegation of the Attorney General, including placing special conditions on all grants, and determining priority purposes for formula grants." 34 U.S.C. § 10102(a)(6) (emphasis added). Section 10102(a)(6), which is located in a different chapter of the *United States Code* from the Byrne JAG statute, merely delegates to the Assistant Attorney General for OJP whatever powers the U.S. Attorney General has been granted elsewhere by statute. *See Chicago*, 888 F.3d at 286-87. As the Seventh Circuit has noted, it is "inconceivable" that Congress could have intended the language in a provision enumerating the "otherwise-ministerial powers" of the Assistant Attorney General for OJP to have conferred the authority to "abrogate the entire distribution scheme and deny all funds to states and

localities . . . based on the Assistant Attorney General’s decision to impose his or her own conditions.” *Chicago*, 888 F.3d at 286.

The district court correctly recognized that “special conditions” is a long-established term of art in the federal grant-making context that refers only to those grant conditions applying to “high-risk grantees”—as distinguished from conditions that are generally applicable to all grants under a particular grant program. *See Philadelphia*, 280 F. Supp. 3d at 617; *see also Chicago*, 888 F.3d at 285 n.2; *California Actions*, 2018 WL 4859528, at *12 n.2. The federal Office of Management and Budget’s (OMB) uniform administrative rules governing federal grants to States and localities dating back to the 1980s have consistently used “special conditions” in this same way. *See, e.g.*, 53 Fed. Reg. 8,034, 8,090 (Mar. 11, 1988). Other authorities on federal grants similarly confirm this well-known understanding of the term.¹¹

¹¹ Dembling & Mason, *supra* n.8, § 11.01, at 107 (“special conditions” are those tailored to specific problems posed by particular grantees) (Add. 112); Malcolm S. Mason, *Monitoring of Grantee Performance, in Federal Grant Law* 79, 86 (Malcolm S. Mason ed., 1982) (“special conditions” are those applied to “high-risk grantees”) (Add. 113).

Indeed, when Congress amended § 10102(a)(6) in 2006 to add the “special conditions” language, DOJ’s own regulation defined the term as a condition that is imposed to address financial or performance concerns specific to a particular applicant. *See* 28 C.F.R. § 66.12 (2006).¹² Such a condition might include, for example, a requirement that a financially unstable grantee provide a more detailed financial report, or be subject to additional monitoring. *Id.* § 66.12(b)(3)-(4).¹³ Under established

¹² 28 C.F.R. § 66.12 (2006) provided, in relevant part:

- (a) A grantee or subgrantee may be considered “high risk” if an awarding agency determines that a grantee or subgrantee: (1) Has a history of unsatisfactory performance, or (2) Is not financially stable, or . . . (5) Is otherwise not responsible; and if the awarding agency determines that an award will be made, special conditions and/or restrictions shall correspond to the high risk condition and shall be included in the award.
- (b) Special conditions or restrictions may include: (1) Payment on a reimbursement basis; (2) Withholding authority to proceed to the next phase until receipt of evidence of acceptable performance within a given funding period; (3) Requiring additional, more detailed financial reports; (4) Additional project monitoring; (5) Requiring the grantee or subgrantee to obtain technical or management assistance; or (6) Establishing additional prior approvals.

¹³ In 2014, DOJ repealed § 66.12 and adopted a virtually identical substitute promulgated by OMB in 2 C.F.R. part 200. *See* 79 Fed. Reg. 75,872, 76,081 (Dec. 19, 2014). That OMB regulation—which is still in effect today and governs all OJP grants including Byrne JAG—uses the

approaches to statutory construction, this history and context offers strong support for reading § 10102(a)(6) to incorporate the long-established and well-understood regulatory definition of “special condition.” Courts “assume that when a statute uses [a term of art], Congress intended it to have its established meaning.” *McDermott Int’l, Inc. v. Wilander*, 498 U.S. 337, 342 (1991).

DOJ does not contest that “special conditions” is a term of art. Instead, it contends that the DOJ regulation defining that term “did not purport to describe the universe of all potential special conditions” that may be imposed on grants, and thus “special conditions” can be interpreted to encompass the challenged conditions. *See* Br. at 30. But the regulation made clear that permissible special conditions or restrictions must be tailored to the specific financial or grant-performance risk posed by a particular grantee. *See* 28 C.F.R. § 66.12(a)(5) (2006) (restrictions imposed “shall correspond to the high risk condition”). Here, in contrast, the challenged conditions—which impose new eligibility requirements having nothing to do with remediating a grantee’s specific

phrase “specific conditions” instead of “special conditions,” but the regulations are otherwise substantively the same. *See* 2 C.F.R. § 200.207.

performance or financial risk—are fundamentally different in nature and kind from the types of special conditions expressly identified as permissible under the DOJ regulation. *See id.* § 66.12(b)(1)-(6) (describing permissible special conditions); *see also* 2 C.F.R. § 200.207. Regardless, since DOJ does not contend that Philadelphia should be considered “high-risk” within the meaning of the regulation,¹⁴ there is simply no basis for DOJ’s suggestion (Br. at 30) that the challenged conditions may be imposed even as grantee-specific “special conditions” pursuant to § 10102(a)(6).¹⁵

¹⁴ The regulation expressly identified the factors warranting treatment of a grantee as “high-risk” and thus properly subject to a “special condition.” *See* 28 C.F.R. § 66.12(a)(1)-(5) (2006), *supra* n.11; *see also* 2 C.F.R. § 200.207(a).

¹⁵ DOJ is not aided by its claimed prior reliance on § 10102(a)(6) (*see* Br. at 11) when requiring all grantees to comply with certain conditions expressly authorized by the Byrne JAG statute or by other federal authorities governing federal grants or grant-making, or to spend *disbursed* Byrne JAG funds in certain ways falling within the eight broad purposes enumerated in § 10152(a)(1). None of those practices support DOJ’s claim (*see* Br. at 11, 23-24) that § 10102(a)(6) gives it broad authority to withhold Byrne JAG grant funds altogether based on *conditions of its own choosing*. Moreover, DOJ’s mislabeling of these generally-applicable conditions as “special conditions” does not inform the relevant inquiry of what *Congress* intended “special conditions” to mean when the language was enacted in § 10102(a)(6).

Nor is DOJ's currently proffered construction of "special conditions" consistent with how OJP itself has used that term in the administration of the Byrne JAG program. In the FY 2018 Byrne JAG Solicitation, for example, OJP uses "special conditions" to refer to conditions that may be applied to a State based on OJP's "pre-award risk assessment" of the State's "financial management and internal control system."¹⁶

DOJ fares no better with its contention (Br. at 30) that the challenged conditions are "priority purposes" under § 10102(a)(6). Here, Congress has determined that *every* State and certain localities are eligible to receive Byrne JAG funds so long as they use the funding for one of the broad purposes permitted by statute, and submit an application in accordance with the requirements of 34 U.S.C. § 10153(a). *See* 34 U.S.C. §§ 10152(a)(1)(A-H), 10156(a)-(d). It would be "at odds with the nature of the Byrne JAG grant" as a mandatory formula grant—and not a discretionary grant—to read the "special conditions" and "priority purposes" language in § 10102(a)(6) as giving DOJ open-ended authority to impose new conditions of eligibility on Byrne JAG grantees. *See*

¹⁶ FY 2018 Byrne JAG Solicitation, *supra* n.7, at 26.

Chicago, 888 F.3d at 285. For these reasons, the district court correctly rejected DOJ's argument that § 10102(a)(6) authorizes it to withhold the Byrne JAG grant upon a grantee's noncompliance with the challenged conditions. *See Philadelphia*, 280 F. Supp. 3d at 616-17. Every other court to have passed on this question has reached this same conclusion. *See Chicago*, 888 F.3d at 286-87; *City of Chicago v. Sessions*, 321 F. Supp. 3d at 873-74; *California Actions*, 2018 WL 4859528, at *12-13. Aside from § 10102(a)(6), DOJ has not identified any statute which purportedly authorizes the U.S. Attorney General to impose the Notice and Access conditions on the disbursement of the Byrne JAG funds.

C. The § 1373 Requirement Is Not Authorized by 34 U.S.C. § 10153(a)(5)(D).

DOJ likewise misplaces its reliance (*see* Br. at 36) on 34 U.S.C. § 10153(a)(5)(D): DOJ's claimed additional source of authority for its requirement that Byrne JAG grantees certify their and their subgrantees' compliance with 8 U.S.C. § 1373(a), which provides that State or local governments and officials "may not prohibit, or in any way restrict, any government entity or official from" communicating with federal immigration officials "regarding the citizenship or immigration status,

lawful or unlawful, of any individual.” Section 10153 requires an applicant for Byrne JAG funds to submit an application certifying that the applicant “will comply with all provisions of this part and *all other* applicable Federal laws.” 34 U.S.C. § 10153(a)(5)(D) (emphasis added). The text and structure of § 10153—which appears in an administrative provision authorizing the Attorney General to promulgate the *form* of applications and certifications—establish that “applicable Federal laws” refers only to the body of laws that by their express text apply to federal grants. *See California Actions*, 2018 WL 4859528, at *18. Indeed, DOJ itself has used the term in the certification context in this very way—that is, to refer to those “federal laws . . . *applicable to the award.*”¹⁷ *See id.* at *17 (emphasis added; quotation marks omitted).

Section 1373 is not an “applicable” law within the meaning of § 10153(a)(5)(D). *See id.* at *17-18. Indeed, § 1373 concerns information-sharing with federal authorities, does not reference any limits on the use of federal funds, and is textually unconnected to the Byrne JAG program as well as to federal grant-making in general. *Compare* 42 U.S.C. § 2000d

¹⁷ DOJ, Certified Standard Assurances § 3(a), at 1 (exp. May 31, 2019).

(providing that “[n]o person in the United States shall, on the ground of race, color, or national origin, be excluded from participation in . . . any program or activity receiving Federal financial assistance”).

Section 10153’s legislative history further supports the reading that it does not apply to non-grantmaking statutes like § 1373. The relevant language was first enacted in the Justice System Improvement Act of 1979, which reauthorized a predecessor to Byrne JAG. *See* Pub. L. No. 96-157, § 2, secs. 401-05, 93 Stat. 1167, 1179-92 (amending the 1968 block grant legislation).¹⁸ At that time, DOJ understood the term “applicable Federal laws” to refer to statutes that govern the provision of federal financial assistance.¹⁹ For example, DOJ’s Law Enforcement Assistance Administration (LEAA)—the agency responsible for administering law-enforcement grants—issued manuals providing

¹⁸ The relevant language in the 1979 Act was codified in 42 U.S.C. § 3743, which, like 34 U.S.C. § 10153, codified grant application requirements, including that an applicant certify it “will comply with all provisions of this title and *all other applicable Federal laws.*” Pub. L. No. 96-157, § 2, sec. 403(a)(8), 93 Stat. at 1188 (emphasis added). (Add. 33.)

¹⁹ *See, e.g.,* DOJ, Law Enforcement Assistance Admin. (LEAA), *General Briefing 6* (1977) (identifying twenty-three laws “applicable” to DOJ grants, and providing the National Environmental Protection Act and civil rights statutes as examples) (Add. 39).

“guidance to grantees on their responsibilities of [sic] *applicable federal laws and regulations*” (emphasis added).²⁰ A 1978 manual lists the laws DOJ understood to be applicable to federal law-enforcement grants, and the list contains only statutes governing federal grant-making. (Add. 6-30.)

Absent some contrary indication, when Congress incorporates a term of art into a statute, courts “assume” that “Congress intended” the language “to have its established meaning.” *McDermott*, 498 U.S. at 342. The inference is particularly strong here because Congress knew of DOJ’s understanding. In 1977, DOJ prepared a report identifying the laws that DOJ deemed applicable to law-enforcement block grants: approximately twenty federal laws that, by their terms, governed federal grant-making.²¹ The report was distributed to every Member of Congress and every governor—among others—and was subject to public comment and

²⁰ *Amendments to Title I (LEAA) of the Omnibus Crime Control and Safe Streets Act: Hearing Before the Subcomm. on Criminal Laws and Procedures of the S. Judiciary Comm.*, 94th Cong. 404 (1976) (statement of Richard Velde, LEAA Administrator). (Add. 82.)

²¹ See DOJ, *Restructuring the Justice Department’s Program of Assistance to State and Local Governments for Crime Control and Criminal Justice System Improvement* 8-9 (June 23, 1977) (“Restructuring Report”).

hearings.²²

Construing the term “all other applicable Federal laws” to include any and all federal statutes of DOJ’s choosing would, as the district court correctly determined, impermissibly convert the Byrne JAG program into a discretionary grant—a result that “would upend the formula approach that Congress created.” *Philadelphia*, 280 F. Supp. 3d at 618; *see also id.* at 616-17; *Chicago*, 888 F.3d at 286-87. Such an absurd result should be avoided as it is at odds with the general legislative purpose underlying the statute. *See Griffin v. Oceanic Contractors, Inc.*, 458 U.S. 564, 575 (1982).

DOJ’s construction of § 10153(a)(5)(D) also runs contrary to one of the main goals of the 1979 Act that introduced the relevant language: to reduce administrative burdens associated with DOJ grants.²³ One of the

²² *See Restructuring the Law Enforcement Assistance Administration: Hearings Before the Subcomm. on Crime of the H. Comm. on the Judiciary*, 95th Cong. 3, 9 (1977). (Add. 85, 87.)

²³ *See, e.g., Federal Assistance to State and Local Criminal Justice Agencies: Hearing Before the Subcomm. on Criminal Laws and Procedures of the S. Comm. on the Judiciary*, 95th Cong. 383 (1978) (stating that the bill was “designed” to “simplify[] the grant process”) (Add. 91); Office of Representative Peter W. Rodino, Press Release, *Committee Approves LEAA Reorganization 1* (May 10, 1979) (noting the 1979 Act was “designed to drastically reduce the red tape which has

central concerns highlighted in DOJ's 1977 report was that the then-body of federal laws applicable to law-enforcement block grants—the approximately twenty statutes scattered across the *United States Code* that applied to federal grant-making—imposed excessive burdens on grantees.²⁴ It is unlikely that the relevant language would have been supported by DOJ and enacted by Congress if either entity believed it could be used to drastically increase the compliance burdens on States and localities, as DOJ is currently attempting to do.

D. Section 1373 Violates the Tenth Amendment.

The § 1373 requirement is unlawful for another reason: the underlying statute—8 U.S.C. § 1373—is invalid under the Supreme Court's recent decision in *Murphy v. National Collegiate Athletic Ass'n*, 138 S. Ct. 1461, 1478 (2018). In *Murphy*, the Supreme Court struck down as unconstitutional a federal statute that prohibited, among other things,

plagued the process of getting federal assistance to states and local governments” (quotation marks omitted)) (Add. 94).

²⁴ See *Restructuring Report*, *supra* n.21, at 9 (“Although each of these acts addresses an important national priority, the cumulative effect of their reporting and administrative requirements is staggering by the time they are passed on to a state agency administering the LEAA block grant.”).

“a State or any of its subdivisions” from “authoriz[ing]” sports betting. *Id.* at 1470, 1478. The *Murphy* court thus made clear that the anti-commandeering principles inherent in the Tenth Amendment do not permit Congress to “issue direct orders to state legislatures”—irrespective of the contents of the directive. *Id.* at 1478.

Section 1373(a) provides that a “State, or local government entity or official may not prohibit, or in any way restrict, any government entity or official from sending to, or receiving from” federal immigration officials information “regarding the citizenship or immigration status, lawful or unlawful, of any individual.” This statutory language directly “constrains local rule-making by precluding [local] lawmakers from passing laws . . . that institute locally-preferred policies which run counter to Section 1373.” *Chicago*, 321 F. Supp. 3d at 869. Accordingly, “[s]ection 1373 does just what *Murphy* proscribes: it tells States they may not prohibit (i.e., through legislation) the sharing of information regarding immigration status” with the federal government. *United States v. California*, 314 F. Supp. 3d 1077, 1099 (E.D. Cal. 2018); *California Actions*, 2018 WL 4859528, at *14-17.

DOJ is mistaken in its suggestion that § 1373 “merely prevent[s] the States from obstructing federal regulation of private parties,” and therefore should be analyzed under preemption principles rather than under the Tenth Amendment. *See* Br. at 49. As the Supreme Court clarified in *Murphy*, a federal statute operates to preempt state law only where the federal statute can be reasonably understood as “regulat[ing] the conduct of private actors, not the States.” 138 S. Ct. at 1481. Yet the plain language of § 1373(a) is directed not at a private actor, but at “a State, or local governmental entity or official.” 8 U.S.C. § 1373(a); *see California Actions*, 2018 WL 4859528, at *14 (concluding that § 1373 “does not regulate private actors”). Indeed, DOJ relies on the fact that § 1373 regulates States and localities as an essential part of its argument that § 1373 is an “applicable Federal law” under § 10153(a)(5)(D) (*see* Br. at 37). *See Philadelphia*, 280 F. Supp. 3d at 618 (setting forth DOJ’s argument for what constitutes an “applicable” federal law). Thus, under *Murphy* § 1373 cannot constitute a preemption statute. *See California Actions*, 2018 WL 4859528, at *14.

Where, as here, a statute expressly commands States and their officials “to enact or refrain from enacting state law,” the statute violates

the Constitution’s anti-commandeering proscription, and no preemption analysis can save it. *Murphy*, 138 S. Ct. at 1481. The district court thus correctly held that § 1373 is unconstitutional under *Murphy*. See *Chicago*, 321 F. Supp. 3d at 872; *California Actions*, 2018 WL 4859528, at *16-17.

E. The Challenged Conditions Are Inconsistent with 34 U.S.C. § 10228(a) Because They Seek to Direct and Control the Actions of State and Local Law Enforcement.

All three conditions are also invalid under a separate statutory provision—codified in the same chapter of the *United States Code* as the Byrne JAG statute—which provides that “[n]othing in this chapter or any other Act shall be construed to authorize any department, agency, officer, or employee of the United States to exercise any direction, supervision, or control over any police force or any other criminal justice agency of any State or any political subdivision thereof.” 34 U.S.C. § 10228(a) (emphasis added). Section 10228(a) was enacted in 1968, at the same time when Congress created the first law-enforcement block grant program, to prohibit precisely the type of executive-branch action challenged in this case: the use of federal law-enforcement grants to exert “direction, supervision, or control” over state and local police forces or law-

enforcement agencies. *See* Pub. L. No. 90-351, § 518(a), 82 Stat. at 208. That provision's repeated use of "any" shows Congress's intent to speak broadly. *See Ali v. Federal Bureau of Prisons*, 552 U.S. 214, 218-19 (2008). Applied in the present context, § 10228(a) thus prohibits all of the challenged conditions.

The legislative history of § 10228(a) confirms this result. Opponents of the 1968 block-grant legislation expressed concerns that the U.S. Attorney General would use law-enforcement grants to coerce States and localities into adopting federal law-enforcement priorities.²⁵ Supporters responded that § 10228, which was pending before Congress as part of the 1968 Act, would prohibit such control. U.S. Attorney General Ramsey Clark testified it would violate both "the mandate and spirit" of § 10228(a) to withhold funds because police departments were not run "the way the Attorney General says they must" be, and that § 10228(a) prevented DOJ from imposing extra-statutory conditions on law-

²⁵ *See, e.g.*, S. Rep. No. 90-1097, at 230 (expressing concern that the Act would enable the U.S. Attorney General to "become the director of state and local law enforcement"). (Add. 4.) *See generally* John K. Hudzik et al., *Federal Aid to Criminal Justice: Rhetoric, Results, Lessons* 15, 23-26 (1984). (Add. 97, 98-99.)

enforcement grants.²⁶ Reviewing this history, the only appellate decision to construe § 10228 has observed that § 10228(a)'s purpose was “to shield the routine operations of local police forces from ongoing control by [DOJ]—a control which conceivably could turn the local police into an arm of the federal government.” *Ely v. Velde*, 451 F.2d 1130, 1136 (4th Cir. 1971).

Although arising in a different context, the Supreme Court's anti-commandeering jurisprudence makes clear that compelling state law-enforcement officers to assist in “the administration of a federally enacted regulatory scheme” constitutes impermissible “direction” or “control” and violates the Constitution's anti-commandeering prohibitions. *See Printz v. United States*, 521 U.S. 898, 904, 930, 935 (1997).²⁷ The § 1373 condition requiring grantees to report violations of § 1373 by subgrantees effectively turns States and localities into an enforcement arm of federal

²⁶ *Controlling Crime Through More Effective Law Enforcement: Hearings Before the Subcomm. on Criminal Laws and Procedure of the S. Comm. on the Judiciary*, 90th Cong. 100, 384, 497 (1967). (Add. 105, 107, 109.)

²⁷ The legislation at issue in *Printz*, the Brady Act, violated these prohibitions by requiring local officers to run background checks on handgun purchasers, and requiring state officers “to accept” forms from gun dealers. 521 U.S. at 904-05, 934.

immigration authorities. *See California Actions*, 2018 WL 4859528, at *16 (finding that § 1373 “shifts a portion of immigration enforcement costs onto the States”). The burdens imposed by the § 1373 certification requirement are particularly onerous with respect to amici States with large numbers of subgrantees. For example, in 2016, New York disbursed Byrne JAG funds to over 110 subgrantees, including many towns, counties, and local law-enforcement and social services agencies.²⁸ And all of the challenged conditions are unlawful under § 10228(a) because they (1) require state officials to administer federal immigration policy by mandating that those officials respond to federal requests for information, and (2) require state officials to devote staff, resources, and real property to facilitate federal agents’ access to aliens in correctional facilities, and to continuously monitor subgrantees for compliance with § 1373. *See Printz*, 521 U.S. at 904.

²⁸ Decl. of Michael Charles Green ¶ 19, *New York v. DOJ*, No. 18-cv-6471 (S.D.N.Y. Aug. 17, 2018), ECF No. 59.

CONCLUSION

The Court should affirm the judgment of the district court.

Dated: New York, NY
October 11, 2018

Respectfully submitted,

BARBARA D. UNDERWOOD
Attorney General
State of New York

By: /s/ Linda Fang
LINDA FANG
Assistant Solicitor General

ANISHA S. DASGUPTA
Deputy Solicitor General
LINDA FANG
Assistant Solicitor General
ERIC R. HAREN
Special Counsel and Assistant
Solicitor General
of Counsel

28 Liberty Street
New York, NY 10005
(212) 416-8656

(Counsel listing continues on next page.)

XAVIER BECERRA
Attorney General
State of California
1300 I Street
Sacramento, CA 95814

BRIAN E. FROSH
Attorney General
State of Maryland
200 Saint Paul Place
Baltimore, MD 21202

GEORGE JEPSEN
Attorney General
State of Connecticut
55 Elm Street
Hartford, CT 06106

MAURA HEALEY
Attorney General
Commonwealth of
Massachusetts
One Ashburton Place
Boston, MA 02108

MATTHEW P. DENN
Attorney General
State of Delaware
Carvel State Bldg., 6th Fl.
820 North French Street
Wilmington, DE 19801

GURBIR S. GREWAL
Attorney General
State of New Jersey
Hughes Justice Complex
25 Market Street
Trenton, NJ 08625

LISA MADIGAN
Attorney General
State of Illinois
100 W. Randolph Street, 12th Fl.
Chicago, IL 60601

HECTOR BALDERAS
Attorney General
State of New Mexico
408 Galisteo Street
Santa Fe, NM 87501

THOMAS J. MILLER
Attorney General
State of Iowa
1305 E. Walnut Street
Des Moines, IA 50319

ELLEN F. ROSENBLUM
Attorney General
State of Oregon
1162 Court Street, N.E.
Salem, OR 97301

(Counsel listing continues on next page.)

PETER F. KILMARTIN
Attorney General
State of Rhode Island
150 South Main Street
Providence, RI 02903

THOMAS J. DONOVAN, JR.
Attorney General
State of Vermont
109 State Street
Montpelier, VT 05609

ROBERT W. FERGUSON
Attorney General
State of Washington
P.O. Box 40100
Olympia, WA 98504

KARL A. RACINE
Attorney General
District of Columbia
One Judiciary Square
441 4th Street, N.W.
Washington, DC 20001

COMBINED CERTIFICATIONS

Linda Fang certifies under penalty of perjury under 28 U.S.C. § 1746 that:

1. I am a member of the bar of this Court.
2. This brief complies with the typeface requirements and length limits of Rule 32(a)(5)-(7) of the Federal Rules of Appellate Procedure.
3. All parties of record are Filing Users and, as required by 3d Cir. L.A.R. 113.4, this brief has been served electronically by the Notice of Docket Activity.
4. The text of the electronic file of this brief is identical to the text of the paper copies of this brief.
5. I caused the electronic version of this brief to be checked for computer viruses using McAfee VirusScan Enterprise + AntiSpyware Enterprise 8.8. No computer viruses were found.

Dated: October 11, 2018

/s/ Linda Fang

Addendum

TABLE OF CONTENTS

	PAGE
Senate Report No. 90-1097 (1968)	ADD1
Dep't of Justice, <i>Guide for Discretionary Grant Programs</i> (1978)	ADD6
Justice System Improvement Act, Pub. L. No. 96-157, 93 Stat. 1167 (1979)	ADD31
Dep't of Justice, Law Enforcement Assistance Admin., <i>General Briefing</i> (1977)	ADD34
<i>Amendments to Title I (LEAA) of the Omnibus Crime Control and Safe Streets Act: Hearing Before the Subcomm. on Criminal Laws and Procedures of the S. Judiciary Comm., 94th Cong. (1976)</i>	<i>ADD80</i>
<i>Restructuring the Law Enforcement Assistance Administration: Hearings Before the Subcomm. on Crime of the H. Comm. on the Judiciary, 95th Cong. (1977).....</i>	<i>ADD84</i>
<i>Federal Assistance to State and Local Criminal Justice Agencies: Hearing Before the Subcomm. on Criminal Laws and Procedures of the S. Comm. on the Judiciary, 95th Cong. (1978)</i>	<i>ADD88</i>
Office of Representative Peter W. Rodino, Press Release, <i>Committee Approves LEAA Reorganization</i> (May 10, 1979)	ADD94
John K. Hudzik et al., <i>Federal Aid to Criminal Justice: Rhetoric, Results, Lessons</i> (1984)	ADD96

TABLE OF CONTENTS

	PAGE
<i>Controlling Crime Through More Effective Law Enforcement: Hearings Before the Subcommittee on Criminal Laws and Procedure of the Senate Committee on the Judiciary, 90th Cong. (1967)</i>	ADD104
Paul G. Dembling & Malcolm S. Mason, <i>Essentials of Grant Law Practice</i> (1991).....	ADD110
Malcolm S. Mason, <i>Monitoring Grantee Performance, in Federal Grant Law</i> (Malcolm S. Mason ed., 1982)	ADD112

Calendar No. 1080

90TH CONGRESS } SENATE { REPORT
2d Session } No. 1097

OMNIBUS CRIME CONTROL AND SAFE STREETS ACT OF 1967

APRIL 29, 1968.—Ordered to be printed

Mr. McCLELLAN, from the Committee on the Judiciary,

REPORT

Submitted the following
together with

MINORITY, INDIVIDUAL, AND ADDITIONAL VIEWS

[To accompany S. 917]

The Committee on the Judiciary, to which was referred the bill (S. 917) to assist State and local governments in reducing the incidence of crime, to increase the effectiveness, fairness, and coordination of law enforcement and criminal justice systems at all levels of government, and for other purposes, having considered the same, reports favorably thereon, with an amendment in the nature of a substitute, and recommends that the bill, as amended, do pass.

AMENDMENT

Strike out all after the enacting clause and insert in lieu thereof the following:

That this Act may be cited as the "Omnibus Crime Control and Safe Streets Act of 1967".

TITLE I—LAW ENFORCEMENT ASSISTANCE

DECLARATIONS AND PURPOSE

Congress finds that the high incidence of crime in the United States threatens the peace, security, and general welfare of the Nation and its citizens. To prevent crime and to insure the greater safety of the people, law enforcement efforts must be better coordinated, intensified, and made more effective at all levels of government.

Congress finds further that crime is essentially a local problem that must be dealt with by State and local governments if it is to be controlled effectively.

It is therefore the declared policy of the Congress to assist State and local governments in strengthening and improving law enforcement at every level by national assistance. It is the purpose of this title to (1) encourage States and units of general local government to prepare and adopt comprehensive plans based upon their evaluation of State and local problems of law enforcement; (2) authorize grants to States and units of local government in order to improve and strengthen law enforcement; and (3) encourage research and development directed toward the improvement of law enforcement and the development of new methods for the prevention and reduction of crime and the detection and apprehension of criminals.

PART A—LAW ENFORCEMENT ASSISTANCE ADMINISTRATION

Sec. 101. (a) There is hereby established within the Department of Justice, under the general authority of the Attorney General, a Law Enforcement Assistance Administration (hereafter referred to in this title as "Administration").

(b) The Administration shall be composed of an Administrator of Law Enforcement Assistance and two Associate Administrators of Law Enforcement Assistance, who shall be appointed by the President, by and with the advice and consent of the Senate. No more than two members of the Administration shall be of the same political party, and members shall be appointed with due regard to their fitness, knowledge, and experience to perform the functions, powers, and duties vested in the Administration by this title.

(c) It shall be the duty of the Administration to exercise all of the functions, powers, and duties created and established by this title, except as otherwise provided.

PART B—PLANNING GRANTS

Sec. 201. It is the purpose of this part to encourage States and units of general local government to prepare and adopt comprehensive law enforcement plans based on their evaluation of State and local problems of law enforcement.

Sec. 202. The Administration is authorized to make grants to States, units of general local government, or combinations of such States or units of local government for preparing, developing, or revising law enforcement plans to carry out the purpose set forth in section 302: *Provided, however,* That no unit of general local government or combination of such units shall be eligible for a grant under this part unless such unit or combination has a population of not less than fifty thousand persons.

Sec. 203. A grant authorized under section 202 shall not exceed 80 per centum of the total cost of the preparation, development, or revision of a plan.

Sec. 204. The Administration may advance such grants authorized under section 202 upon application for the purposes described. Such application shall:

- (1) Set forth programs and activities designed to carry out the purposes of section 302.
- (2) Contain such information as the Administration may prescribe in accordance with section 301.

PART C—GRANTS FOR LAW ENFORCEMENT PURPOSES

Sec. 301. It is the purpose of this part to encourage States and units of general local government to carry out programs and projects to improve and strengthen law enforcement.

Sec. 302. (a) The Administration is authorized to make grants to States, units of general local government, and combinations of such States or units of general local government to improve and strengthen law enforcement: *Provided however,* That no unit of general local government or combination of such units shall be eligible for a grant under this part unless such unit or combination has a population of not less than fifty thousand persons.

(b) Under this part grants may be made pursuant to an application which is approved under section 303 for—

- (1) Public protection, including the development, demonstration, evaluation, implementation, and purchase of methods, devices, facilities, and equipment designed to improve and strengthen law enforcement and reduce crime in public and private places.
- (2) The recruiting of law enforcement personnel and the training of personnel in law enforcement.
- (3) Public education relating to crime prevention and encouraging respect for law and order, including education programs in schools and programs to

INDIVIDUAL VIEWS MESSRS. DIRKSEN, HRUSKA, SCOTT, AND THURMOND ON TITLES I, II, AND III

Since 1960, serious crime in the United States has increased an alarming 88 percent. This fact is cause for the gravest national concern. This is not a partisan issue. It is an American tragedy.

In consideration of the omnibus crime bill, we have sought to strengthen and improve the proposal sent to Congress. To a limited extent, these efforts have been successful. The committee bill, however, still needs further upgrading and refinement.

MINORITY CONTRIBUTIONS

The Omnibus Crime Control Act reported by the Senate Judiciary Committee bears an unmistakable imprint of constructive Republican contributions. These contributions range from new substantive provisions to perfecting technical changes.

ORGANIZED CRIME

The most significant Republican contributions to the bill are those which increase significantly the tools and financial resources to combat the scourge of organized crime. In this regard, two major provisions were added at our insistence.

First, the substance of Amendment 223, introduced on June 29, 1967, by Senators Dirksen, Hruska, Scott, Thurmond and several others, has been approved. The amendment creates a category of special financial assistance to state and local governments. Such assistance has two purposes:

(1) To assist in the establishment or expansion of special prosecuting groups on a local level to ferret out and prosecute the multifarious illegal activities of organized crime.

(2) To provide special federal assistance in establishing a coordinated intelligence network among states including computerized data banks of syndicate operations and activities. These efforts would be under the direction and control of State Organized Crime Councils. A special authorization up to \$15 million for fiscal year 1969 would be available for this purpose.

ELECTRONIC SURVEILLANCE

Another major contribution to efforts to combat organized crime is found in Title III of the committee bill. To a great degree, this title reflects the provisions of S. 2050, the proposed Electronic Surveillance Act of 1967, which was introduced by Senators Dirksen, Hruska, Scott, Thurmond, Percy, Hansen and others in June of 1967. Included in the committee bill is the formula for strict impartial court authorization and supervision of surveillance and a broad prohibition on private snooping. S. 2050 was introduced in the wake of the Supreme Court's decision of *Berger v. New York*. It was tailored to meet the constitutional requirements imposed by that decision.

(324)

ADD3

INDEPENDENT LAW ENFORCEMENT ASSISTANCE ADMINISTRATION

In pursuit of one of the same objectives of the block grant provisions, namely the prevention of federal domination and control of state and local law enforcement, the Criminal Laws Subcommittee, upon the initiative of Chairman McClellan, added a provision to its bill for the establishment of an independent Law Enforcement Assistance Administration to administer the federal aid program. The administering agency was to be headed by a three-man board appointed by the President with the advice and consent of the Senate. Minority party representation was assured by the requirement that one of the three men would be a representative of the party out of power.

The subcommittee bill provided:

In the exercise of its functions, powers, and duties, the Administration shall be independent of the Attorney General and other offices and officers of the Department of Justice.

This was deemed essential to insure that, as much as possible, the law enforcement assistance program would be administered impartially and free from political pressures. Also, it was considered to be important to refrain from placing in the hands of one man the potential power of granting or denying federal financial assistance in very large amounts to state and city law enforcement agencies.

It is regrettable that the provision for the independent status of the Administration was dropped from the bill. We attempted unsuccessfully to reinstate the provision in the full committee, and will urge its adoption on the floor of the Senate.

In short, we don't want the Attorney General, the so-called "Mr. Big" of federal law enforcement to become the director of state and local law enforcement as well. It is true that the Attorney General is chief law enforcement officer of the federal government. But he is not chief law enforcement officer of states or cities. We believe America does not want him to serve in this latter capacity.

Organization and management experts may object to a dilution of executive authority, but we want no part of a national police force. Such dilution, if a price at all, is a small price to pay to preserve a fundamental balance of police power.

We don't want this bill to become the vehicle for the imposition of federal guidelines, controls, and domination.

POLICE SALARY SUPPORT

The Administration's original proposal to Congress in early 1967 contained a feature allowing up to one-third of each federal grant to be utilized for compensation of law enforcement personnel. In the hearing record of both the House and Senate Judiciary Committees, this provision proved to be quite controversial. When the House Committee reported the bill, the provision for salary support was deleted. Commenting on this action, the committee report on page 6 stated:

The committee deleted all authority to use grant funds authorized by the bill for the purpose of direct compensation to police and other law enforcement personnel other than for training programs or for the performance of innovative

functions. Deletion of authority to use Federal funds for local law enforcement personnel compensation underscores the committee's concern that responsibility for law enforcement not be shifted from State and local government level. It is anticipated that local governments, as the cost for research, innovative services, training, and new equipment developments are shared by the Federal Government in the programs authorized in the bill will be able to devote more of their local resources to the solution of personnel compensation problems. The committee recognizes that adequate compensation for law enforcement personnel is one of the most vexing problems in the fight against crime.

We wholeheartedly subscribe to the House committee's view. There is indeed a grave concern that responsibility for law enforcement not be shifted from the state and local levels.

The Senate Criminal Laws Subcommittee also deleted a similar provision by an overwhelming vote, but subsequently a somewhat modified salary provision was reinstated. In modified form, up to one-third of each grant could be made available to pay one-half the cost of salary *increases* for law enforcement personnel. Even with this modification, we must strongly oppose the provision. This is not because we are indifferent to the low pay of the nation's law enforcement officers. It is because we fear that "he who pays the piper calls the tune" and that dependence upon the federal government for salaries could be an easy street to federal domination and control.

In addition, this provision would not have equal application or provide equal benefits to all law enforcement officials. In fact, most of the nation's 400,000 police officers would not be eligible because under the committee bill only local jurisdictions or groups of local jurisdictions with populations of more than 50,000 would be eligible to apply for grant aid. Thus, those smaller jurisdictions, some 80 percent of the nation's total with 58 percent of the population, would not be eligible for grant assistance. Who is to say that the officers of City A which meets the population standard could receive federal salary supplements whereas the officers of City B, perhaps an adjoining community whose population requirements do not meet the test, could not qualify.

The unfairness of the Administration proposal becomes crystal clear when it is considered that not all large cities and policemen will be beneficiaries of federal law enforcement grants. This is so because there is simply not enough federal money to go around. Thus, City C which perhaps got its application in early or whose political leadership was in favor with the Department of Justice received a grant and salary support, while City D with the same needs, the same crime problems and same low pay scales was left out because its application was tardy or not in compliance with contemporary federal notions on what a good application should contain. What could be more manifestly unfair?

Finally, it should be noted that once salary support is granted, it would be difficult if not impossible for the federal government to abandon its assistance, thus leaving a permanent dependence on the federal treasury.

TITLE II

The spectre of American society—the greatest in the history of the world—plunging into chaos as the national fabric unravels into law-

Guideline Manual

M 4500.1G

GUIDE FOR DISCRETIONARY GRANT PROGRAMS



September 30, 1978

UNITED STATES DEPARTMENT OF JUSTICE
LAW ENFORCEMENT ASSISTANCE ADMINISTRATION

Distribution:

Initiated By:

ADD6

M 4500.1G
September 30, 1978

INTRODUCTION

1. PURPOSE. The purpose of this manual is to provide information about major categorical programs of the Law Enforcement Assistance Administration, authorized by the Crime Control and Safe Streets Act of 1968, as amended, and the Juvenile Justice and Delinquency Prevention Act of 1974, as amended. The manual includes information about discretionary grant programs, selected program field tests, technical assistance, and training. Information about how to apply for assistance and who to contact for additional information is also provided.

This manual is complemented by additional guidelines and program announcements and plans, such as the Program Plan of the National Institute of Law Enforcement and Criminal Justice, the Program Plan for Statistics of the National Criminal Justice Information and Statistics Service, program guidelines of the Office of Criminal Justice Education and Training, and program announcements and other documents regarding Incentive Programs. In addition, supplements to this manual will be published as new programs, such as those of the Office of Juvenile Justice and Delinquency Prevention, are developed.

2. SCOPE. This manual is of interest to State and local criminal justice agencies, institutions and organizations who work with criminal justice agencies, State Planning Agencies, regional and local planning units, and LEAA personnel.
3. CANCELLATION. LEAA Guideline Manual M 4500.1F, December 21, 1977, same subject, is herewith cancelled.
4. INTRODUCTION. Many of the programs in this manual reflect the implementation of the Action Program Development Process in LEAA during the past year. The Action Program Development Process is an effort to improve the value and effectiveness of LEAA action programs by systematically building on knowledge about concepts, approaches, and techniques which are successful in controlling crime and improving criminal justice, carefully testing program concepts, demonstrating programs which are successful, and marketing concepts through training and technical assistance.

Programs which are currently in the stages of program design and testing as well as demonstration, are included in this manual. Major technical assistance and training programs which serve to market program concepts and techniques are also included.

LEAA programs will increasingly be developed through the Action Program Development Process.

M 4500.1G
September 30, 1978

5. RELATED GUIDELINES AND DOCUMENTS.

- a. The Programs described in this manual are supported and supplemented by a number of other LEAA programs. The major documents describing other programs and the general procedures governing them include:
- (1) Guide for State Planning Agency Grants (effective edition of M 4100.1) which describes the procedures and requirements for planning grants to State Criminal Justice Planning Agencies (SPA's) supported under Part B of the Crime Control and Safe Streets Act of 1968, as amended, and for the development of State comprehensive criminal justice plans required under Part C and E of the Crime Control Act, and the Juvenile Justice and Delinquency Prevention Act of 1974, as amended.
 - (2) Program Plan for the National Institute of Law Enforcement and Criminal Justice (NILECJ) which describes the research, development and technology transfer activities planned for NILECJ.
 - (3) Program Plan for Statistics FY 1977-81 which describes LEAA's planned statistical activities.
 - (4) Law Enforcement Education Program Guideline Manual (effective edition of M 5200.1) which describes the education assistance program of the Office of Criminal Justice Education and Training (OCJET).
 - (5) Graduate Research Fellowship Program Guideline (effective edition of G 5400.2) which describes the procedures and requirements for participation in the LEAA Graduate Research Fellows Program.
 - (6) Guideline Manual for the Comprehensive Data Systems Program (effective edition of M6640.1) which describes the Comprehensive Data Systems Program (CDS), sets forth guidelines for CDS action plans, and indicates the purpose, available funding, and criteria for evaluation of CDS applications.
 - (7) Guideline Manual for Financial Management for Planning and Action Grants (effective edition of M 7100.1), which describes the requirements and procedures for financial management of LEAA grants, including those set forth in this manual.
 - (8) Program Announcement for Incentive Fund Programs, which describes the concept, background, and procedures governing LEAA's newly developed Incentive Fund grant programs. The program announcement will be available early in FY 1979.

September 30, 1978

- b. These documents are available from LEAA, 633 Indiana Avenue, N.W. Washington, D.C. 20531.
- c. In addition, the National Criminal Justice Reference Service (NCJRS) can provide a wide range of information about specific areas of interest to the criminal justice community. Information about these services is available from LEAA or directly from NCJRS, Box 6000, Rockville, Maryland 20850.
- d. For further information or assistance in the use of this manual, contact LEAA offices referred to herein or the appropriate State Planning Agency.

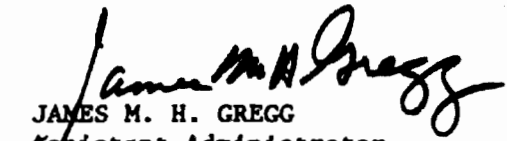
JAMES M. H. GREGG
Assistant Administrator
Office of Planning and Management

111

ADD9

M 4500.1G
September 30, 1978

TABLE OF CONTENTS

<u>CHAPTER 1</u> <u>PREVENTION PROGRAMS</u>	<u>Page No.</u>	<u>CH</u>
1. Scope of Chapter	1	30
2. Community Anti-Crime Program	1	31
3. Comprehensive Crime Prevention Program	12	3
4. Family Violence Program	19	3
5. Commercial Security Program Test	27	:
6. Reserved	27	:
7. Technical Assistance in Crime Prevention	28	
8. Training in Crime Prevention	30	
9. Reserved	30	
<u>CHAPTER 2</u> <u>ENFORCEMENT PROGRAMS</u>		
10. Scope of Chapter	31	
11. Anti-Fencing Program	31	
12. Organized Crime Program	33	
13. Comprehensive Career Criminal: ICAP Component	34	
14. Arson Control Test	35	
15-16. Reserved	35	
17. Technical Assistance in Enforcement	36	
18. Training in Enforcement	39	
19. Reserved	41	
<u>CHAPTER 3</u> <u>ADJUDICATION PROGRAMS</u>		
20. Scope of Chapter	43	
21. Court Delay Reduction Program	43	
22. Comprehensive Career Criminal Program	51	
23. Fundamental Court Improvement Program	60	
24. Integrated Police and Prosecution Witness Assistance Program	69	
25. State Judicial Information System Program (SJIS)	74	
26. Jail Overcrowding and Pretrial Detainee Program (Adjudication)	77	
27. Technical Assistance in Adjudication	78	
28. Training in Adjudication	81	
29. Reserved	83	

M 4500.1G
September 30, 1978

CHAPTER 4 CORRECTIONS PROGRAMS

	<u>Page No.</u>
30. Scope of Chapter	85
31. Corrections Facility Standards Implementation Program	85
32. Corrections Program Standards Implementation Program	91
33. Correctional Standards Accreditation Program	97
34. Restitution Program	98
35. Treatment Alternatives to Street Crime (TASC) Program	104
36. Treatment and Rehabilitation for Addicted Prisoners Program (TRAP)	107
37. Jail Accounting Microcomputer System (JAMS) Program	112
38. Offender Based State Corrections Information System (OBSCIS) Program	115
39. Inmate Legal Services Program	119
40. Jail Overcrowding and Pretrial Detainee Program	120
41-46. Reserved	127
47. Technical Assistance in Corrections	128
48. Training in Corrections	136
49. Reserved	136

CHAPTER 5 SYSTEM SUPPORT PROGRAMS

50. Scope of Chapter	137
51. Comprehensive Data Systems (CDS) Program	137
52. Small State Supplement Program	141
53. Indian Criminal Justice Program	141
54. Manpower Planning and Development	142
55-56. Reserved	144
57. Technical Assistance in System Support	145
58. Training in System Support	146
59. Reserved	148

CHAPTER 6 JUVENILE JUSTICE AND DELINQUENCY PREVENTION PROGRAMS

60. Juvenile Justice and Delinquency Prevention	149
61. Youth Advocacy - Reserved	149
62. Alternative Education - Reserved	149
63. Children in Custody - Alternative Programs Part II Reserved	149
64. Project New Pride - Replication Program - Reserved	149
65. Juvenile Justice System Reform - Reserved	149

M 4500.1G
September 30, 1978

CHAPTER 6 (Cont.)

66. Announcement of OJDP Unsolicited Proposal Cycle - Reserved	149
67-70. Reserved	
71. Technical Assistance in Juvenile Justice and Delinquency Prevention	150
72. Training in Juvenile Justice and Delinquency Prevention - Reserved	151
APPENDIX 1. GENERAL SPECIFICATIONS AND REQUIREMENTS FOR DISCRETIONARY GRANTS	
1. Scope	1
SECTION 1. ELIGIBLE PROJECTS AND APPLICANTS	
2. Eligible Projects	1
3. Eligible Applicants	1
SECTION 2. GENERAL REQUIREMENTS	
4. Grantee Matching Contribution	3
5. Assumption of Costs	3
6. Period of Support	4
7. Grant Assurances	4
SECTION 3. SPECIAL REQUIREMENTS	
8. Special Requirements for Part E (Corrections) Grants	6
9. Special Requirements for Construction Projects	7
10. Special Requirements for Grants Involving Automated Data Processing (ADP)	8
11. Special Requirements for Multi-State or Multi-Units Projects	9
12. Special Requirements of Other Federal Legislation and Regulations	10
SECTION 4. PROHIBITIONS AND RESTRICTIONS	
13. Lethal Weapons, Ammunition and Related Items	15
14. Medical Research and Psychotherapy	15
15. Expenditures for Personnel	15

M 4500.1G
September 30, 1978

	<u>Page No.</u>
APPENDIX 2. PREPARATION AND SUBMISSION OF APPLICATIONS	
1. Scope	1
SECTION 1. PREPARATION OF APPLICATIONS	
2. Standard Application Forms	1
3. Preapplications	1
SECTION 2. SUBMISSION OF APPLICATIONS	
4. Consultation and Participation with State Planning Agencies	2
5. Submission and Processing Procedures	3
6. Panel Review Process	4
7. Notification	4
APPENDIX 3. AWARD AND ADMINISTRATION OF GRANTS	
1. Scope	1
2. Applicability of Financial Management Guide	1
3. Award and Payment of Funds	1
4. Allowability of Costs	2
5. State Planning Agency Supervision and Monitoring Responsibility	3
6. Audit Responsibilities	4
7. Suspension and Termination of Grants	5
8. Reports Required of Grant Recipients	6
APPENDIX 4. MEASUREMENT OF PERFORMANCE: EVALUATION AND MONITORING OF DISCRETIONARY GRANTS	
1. Background	1
2. The Four Types of Performance Measurement	1
3. Self-Assessment	2
4. LEAA Project Monitoring	2
5. Evaluation Requirements	3
6. Program Evaluation	3
7. Intensive Project Evaluation	6

M 4500.1G
September 30, 1978

Page No.

APPENDIX 5. SPECIAL INSTRUCTIONS FOR NON-CONSTRUCTION GRANT APPLICATIONS

1. Scope	1
2. Part I (Standard Form 424)	1
3. Part III, Budget Information and Budget Narrative	2
4. Part IV, Program Narrative Instructions	4

M 4500.1G
September 30, 1978

**APPENDIX 1. GENERAL SPECIFICATIONS AND REQUIREMENTS FOR
DISCRETIONARY GRANTS**

1. **SCOPE.** This appendix contains general requirements for and limits on use of discretionary funds grants, including eligibility rules, general requirements, prohibitions and restrictions, and other technical requirements.

SECTION 1. ELIGIBLE PROJECTS AND APPLICANTS

2. **ELIGIBLE PROJECTS.**

- a. Applications will normally be considered only if they fall within the scope and coverage of programs described in Chapters 1 through 6 of this Manual.
- b. Applicants seeking categorical funds for projects which do not fall within the scope and coverage of programs described in this Manual should submit a brief pre-application or concept paper describing the objectives, strategies, and resources required for the proposed project, before submitting a formal application.
- c. Applicants are advised that categorical funds for projects not covered by this Manual or by the Program Plan of the National Institute of Law Enforcement and Criminal Justice are extremely limited.

3. **ELIGIBLE APPLICANTS.**

- a. Discretionary grants authorized under Part C (Grants for Law Enforcement Purposes) and Part E (Grants for Correctional Purposes) of the Crime Control and Safe Streets Act can be made only to:
 - (1) State Planning Agencies;
 - (2) Local units of government;
 - (3) Combinations of local units of government; or
 - (4) Non-profit organizations.
- b. Grants may be made to State agencies as co-applicants with or subgrantees of State Planning Agencies.

M 4500.1G
September 30, 1978

- c. Special emphasis grants authorized under Section 224 of the Juvenile Justice and Delinquency Act (Grants for Juvenile Delinquency Prevention and Treatment Programs) can be made to public and private agencies, organizations and institutions. Private non-profit agencies, organizations or institutions must have had experience in dealing with youth.
- (1) A private non-profit agency, organization or institution is defined as any corporation, foundation, trust, association, cooperative, accredited institution of higher education, and any other agency, organization or institution which is operated primarily for scientific, educational, service, charitable, or similar public purposes, but which is not under public supervision or control, and no part of the net earnings of which inures or may lawfully inure to the benefit of any private shareholder or individual, and which has been held by IRS to be tax-exempt under the provisions of Section 501(c) (3) of the 1954 Internal Revenue Code.
 - (2) (a) Experience in dealing with youth means that the non-profit agency, organization or institution has been in existence for at least two years and has established program services for youth related to the program or project for which funding is sought;
 - (b) Under special circumstances the two year requirement may be waived by the Administrator of the Office of Juvenile Justice and Delinquency Prevention.
- d. Programs contemplating action by a particular type of law enforcement agency, or efforts conducted for State and local government by a university or other private agency, must have the application submitted by either:
- (1) The department of state government under whose jurisdiction the project will be conducted; or
 - (2) A unit of general local government, or combination of such units, whose law enforcement agencies, systems, or activities will execute or be benefited by the grant.

App 1 Par 3
Page 2

ADD16

M 4500.1G
September 30, 1978

SECTION 2. GENERAL REQUIREMENTS

4. GRANTEE MATCHING CONTRIBUTION. Applicants for grants authorized under Parts C and E of the Crime Control Act (except Indian Tribes, the Trust Territories, Guam, American Samoa and the Marianas) must provide at least 10 percent of the total project costs. For some programs a larger matching contribution is required for second and subsequent years of award.
- a. Matching contributions must be in cash rather than in-kind goods and services.
 - b. Matching contributions may be funds from State, local or private sources but may not include other Federal funds except where the Federal statute governing the other funds authorizes those funds to be used to match other Federal grants, e.g.:
 - (1) Funds provided by the Housing and Community Development Act of 1974;
 - (2) Funds provided by the Appalachian Regional Development Act of 1965; and
 - (3) Funds provided by the State and Local Fiscal Assistance Act of 1972, as amended (General Revenue Sharing Funds).
 - c. Projects funded under the Juvenile Justice and Delinquency Prevention Act of 1974, as amended, do not require matching funds, unless otherwise designated in the program description
 - d. Community Anti-Crime Program projects (Chapter 1, Paragraph 2) do not require matching funds.
 - e. For more detailed information regarding grantee matching contribution see the effective edition of LEAA M 7100.1.
5. ASSUMPTION OF COSTS. It is LEAA policy that funds are awarded for initial development and demonstration and not for long term support.
- a. Projects will not be funded for a total of more than three years specific justification and approval at the initial award by the Administrator of LEAA.
 - b. Applicants must indicate as part of the initial application how project activities will be paid for when Federal funding ceases what plans will be made during the period of Federal funding to arrange for that funding. This information will be used as one criterion for evaluating applications for funding.

App 1 Par 4
Page 3

ADD17

N 4500.14
September 30, 1978

- c. It is LEAA policy to encourage increasing grantee matching contribution for second and third years of award.
 - d. Juvenile Justice and Delinquency Prevention Act funded programs may be continued for longer periods consistent with LEAA Financial Guideline N 7100.1A, Change 3, Chapter 7, Paragraph 12.
 - e. See individual program descriptions (Chapters 1 through 6) for any special requirements or exemptions with respect to assumption of costs.
6. PERIOD OF SUPPORT.
- a. Projects will normally be awarded funds for a twelve month period.
 - b. Awards for longer periods, not to exceed eighteen months, may be made subject to grantee and LEAA needs.
 - c. Projects exceeding eighteen months require separate applications for specific periods of eighteen months or less.
 - d. Juvenile Justice and Delinquency Prevention Act funded programs may be supported for longer periods of time, consistent with LEAA Financial Guideline N 7100.1A, Change 3, Chapter 7, Paragraph 12.
 - e. Exceptions to funding period limitations, where applicable, are noted in program descriptions (Chapters 1 through 6).
7. GRANT ASSURANCES. The grant assurances contained in Part V of SF 424, Application for Federal Assistance (Appendix 6) are incorporated in and made a part of all discretionary grant awards.
- a. All grant assurances should be reviewed carefully because they define the obligations of grantees and their subgrantees and express commitments that have binding contractual effect when the award is accepted by the grantee.
 - b. Special Conditions. Frequently, LEAA will approve or require, as a condition of grant award and receipt of funds, "special conditions" applicable only to the particular project or type of program receiving grant support. These special conditions are to be negotiated and included in the terms of an award. Notice and opportunity for discussion will be provided to grant applicants. Special conditions may:

M 4500.1G
September 30, 1978

- (1) Set forth specific grant administration policies;
 - (2) Set forth LEAA regulations (e.g., written approval of changes);
 - (3) Seek additional project information or detail;
 - (4) Establish special reporting requirements; and/or
 - (5) Provide for LEAA approval of critical project elements such as key staff, evaluation designs, dissemination of manuscripts, contracts, etc.
- c. All grants are subject to applicable other LEAA guidelines and regulations. Copies of these and other grant condition references may be obtained from LEAA. Major other guidelines and regulations are:
- (1) M 7100.1, Financial Management for Planning and Action Grants, which is the basic fiscal administration manual for LEAA grants;
 - (2) LEAA regulations implementing the provisions of Title VI of the Civil Rights Act of 1964 with respect to LEAA grants (28 CFR 42.101, et. seq., Subpart C);
 - (3) LEAA Nondiscrimination in Federally Assisted Crime Control and Juvenile Delinquency Program (28 C.F.R. 42. 201, et. seq., subpart D) and equal employment opportunity program guidelines (28 C.F.R. 42.301 et. seq., subpart E) with respect to LEAA grants;
 - (4) Department of Justice-LEAA regulations on privacy and security of criminal history information systems (28 C.F.R. Part 20);
 - (5) Department of Justice-LEAA regulations on the Confidentiality of Identifiable Research and Statistical Information (28 C.F.R. Part 22).
- d. The following condition applies to all grants awarded by LEAA:

"THIS GRANT, OR PORTION THEREOF, IS CONDITIONAL UPON SUBSEQUENT CONGRESSIONAL OR EXECUTIVE ACTION WHICH MAY RESULT FROM FEDERAL BUDGET DEFERRAL OR RECISION ACTIONS PURSUANT TO THE AUTHORITY CONTAINED IN SECTIONS 1012(A) AND 1013(A) OF THE CONGRESSIONAL BUDGET AND IMPOUNDMENT CONTROL ACT OF 1974, 31 U.S.C. 1301, PUBLIC LAW 93-344, 88 STAT. 297 (JULY 12, 1974)."

App 1 Par 7
Page 5

ADD19

M 4500-1G
September 30, 1978

SECTION 3. SPECIAL REQUIREMENTS

- 8. SPECIAL REQUIREMENTS FOR PART E (CORRECTIONS) GRANTS.** As a condition for receipt of Part E funds for the planning, construction, acquisition or renovation of adult or juvenile correctional institutions or facilities, ALL applicants for such must demonstrate and provide the following to the extent applicable:
- a. Evidence of reasonable use of alternatives to incarceration, including but not limited to referral and bail practices, diversionary procedures, court sentencing practices, comprehensive probation resources and the minimization of incarceration by State and local parole practices, work-study release or other programs assuring timely release of prisoners under adequate supervision. (Applications should indicate the areas to be served, comparative rates of disposition for fines, suspended sentences, probation, institutional sentences and other alternatives, and rates of parole.);
 - b. Evidence of special provision for the treatment of alcohol and drug abusers in institutions and community-based programs;
 - c. Architectural provision for the complete separation of juvenile, adult female, and adult male offenders;
 - d. Architectural design for new facilities providing for appropriate correctional treatment programs, particularly those involving other community resources and agencies;
 - e. Willingness to accept in the facilities persons charged with or convicted of offenses against the United States, subject to negotiated contractual agreements with the Bureau of Prisons;
 - f. Certification that, where feasible and desirable, provisions will be made for the sharing of correctional institutions and facilities on a regional basis;
 - g. Certification that Part E funds will utilize advanced techniques in the design of institutions and facilities;
 - h. Satisfactory assurances that the personnel standards and programs of the institutions and facilities will reflect advanced practices including designation of the kinds of personnel standards and programs which will be sought in institutions and facilities receiving Part E support; and

M 4500.1G
September 30, 1978

1. Certification that special administrative requirements dealing with objectives, architectural and cost data, contractual arrangements, etc., will be made applicable to contractors.
 - j. All Applications for Part E funds for purposes of construction or renovation of juvenile and adult correctional institutions or facilities MUST BE submitted in accordance with Guideline G 4063.2 (effective edition) to the national contractor to be selected by LEAA for clearance of the architectural plans, designs and construction drawings. Applications should be forwarded to the contractor at the same time they are submitted to the State Planning Agency and to LEAA. In turn, the contractor will respond to the applicant, the State Planning Agency and LEAA.
9. SPECIAL REQUIREMENTS FOR CONSTRUCTION PROJECTS.
- a. Construction grants under Part C are intended to be supportive of and supplemental to programs aimed at crime reduction and criminal justice system improvement. Construction grants under Part E are intended to meet the need for improved correctional facilities, with prime emphasis on community-based correctional facilities, and must be an integral part of a comprehensive plan for correctional programs and facilities.
 - b. New construction projects will be considered for funding only when they represent the only method available to meet program goals of LEAA national programs or of State comprehensive plans.
 - c. Construction projects will be funded only when they meet critical needs, are innovative, and when they involve approaches which are replicable to other jurisdictions:
 - (1) An innovative approach to construction involves special attention to the needs of citizens who come in contact with the criminal justice system, special attention to possible multi-jurisdictional, regional, or multi-purpose use of the facility, among other elements.
 - (2) To be replicable, projects must show how requirements for the facility were developed, how the facility supported the goals, objectives, and priorities of LEAA national programs or State comprehensive plans, and how considerations of program objectives were built into the design of the facility.

September 30, 2018

- d. Applicants must comply with LEAA Guidelines, G 7400.1B, Equal Employment Opportunity Procedure for Submitting Information on Construction and Renovation Contracts and with Executive Orders 11246 and 11375.
 - e. In accordance with the provisions of the Rehabilitation Act of 1973, Pub. L. 93-112, 29 U.S.C. §792, et seq., any building construction funded under the Act for which there is an intended use that will require that such building or facility be accessible to the public or may result in the employment or residence therein of physically handicapped persons must be so constructed as to ensure that physically handicapped persons will have ready access to, and use of, such buildings.
 - f. Construction programs and projects funded under the Juvenile Justice and Delinquency Prevention Act are limited to construction of innovative community based facilities for less than 20 people. Facilities include both buildings, and parts or sections of a building to be used for a particular program or project.
 - (1) Erection of new buildings is not permitted with Juvenile Justice and Delinquency Prevention funds.
 - (2) Federal funds may not be used for more than 50 percent of the cost of construction of a facility developed pursuant to Section 227 of the Juvenile Justice and Delinquency Prevention Act.
 - g. Application for construction projects must be made on Standard Form 424 with LEAA Form 4000/4 (Application for Federal Assistance Construction Program) attached.
 - h. Preapplications must be submitted for construction grants exceeding \$100,000 in Federal funds.
 - i. For more information on definitions and requirements with respect to construction programs, see the effective edition of M 7100.1.
10. SPECIAL REQUIREMENTS FOR GRANTS INVOLVING AUTOMATED DATA PROCESSING (ADP)
In addition to the conditions set forth in this manual which apply to all grants, grantees receiving funds for automated data processing (ADP) must agree:
- a. To use, to the maximum extent practicable, computer software already produced and available without obligation.

App 1 Para 9

Page 8

ADD22

M 4300.1G
September 30, 1978

- b. That all application programs will be written in Federal Standard COBOL or ANS FORTRAN (where the nature of the task requires a scientific programming language) whenever possible. Programs may be written in ANS BASIC for microcomputers and minicomputers subject to the following conditions: grantees will require hardware vendor assurance that the BASIC language facility (including any extensions or additions to the instruction set of ANS BASIC) will be validated by the National Bureau of Standards validation routine; extensions to the ANS BASIC instruction will be limited to those instructions agreed upon by mutual agreement after consultation with at least three hardware manufacturers; program applications, whether new or transferred, will run on the hardware of at least three manufacturers.
 - c. That grant funds will not be used for lease, maintenance, or engineering costs of proprietary applications software packages without specific, prior approval of LEAA.
 - d. That all computer software written under the grant will be made available to LEAA for transfer to authorized users in the criminal justice community without cost other than that directly associated with the transfer and that the system will be documented in sufficient detail to enable a competent data processing staff to adapt the system, or portions thereof, to usage on a computer of similar size and configuration, of any manufacturer.
 - e. To provide a complete copy of documentation, upon request, to the Systems Development Division, National Criminal Justice Information and Statistics Service, LEAA. Documentation will include, but not be limited to, Systems description, Operating Instructions, User Instructions, Program Maintenance Instructions, input forms, file descriptions, report formats, program listings, and flow charts for the system and programs. Grantee agrees to produce system documentation for this grant in accordance with Federal Information Processing Standards (FIPS PUB 38).
 - f. To incorporate the provisions of all applicable conditions of the grant into all requests for proposal (RFP), requests for quotation (RFQ), information for bid (IFB), and contracts utilizing funds from the grant in order that contractors concerned will be guided by the LEAA requirements.
 - g. That conversion cost in itself will not be used to justify sole source procurement of ADP equipment.
11. SPECIAL REQUIREMENTS FOR MULTI-STATE OR MULTI-UNITS PROJECTS. Several discretionary programs encourage multi-State, regional, or cooperative projects involving multiple units of State or local government.
- a. Unless otherwise indicated in the specifications for a particular program, applications may be made by:

App 1 Para 10
Page 9

ADD23

M 4500.1G
September 30, 1978

- (1) One government unit in the group on behalf of the others;
 - (2) All units in the group jointly; or
 - (3) A special combination, association or joint venture created by a group of governmental units for general or grant application purposes.
- b. In all cases, clear evidence will be required of approval by all participating units of government with respect to:
- (1) Their participation in the project; and
 - (2) The terms and commitments of the grant proposal or application.

12. SPECIAL REQUIREMENTS OF OTHER FEDERAL LEGISLATION AND REGULATIONS.
LEAA is required to insure that all discretionary grants meet certain administrative and legal requirements imposed by other laws and administrative issuances. Therefore, the applicant must insure that the following requirements are met:

- a. Clean Air Act Violations. In accordance with the provisions of the Clean Air Act (42 U.S.C. 1857) as amended by Public Law 91-604, the Federal Water Pollution Act (33 U.S.C. 1251 et seq.) as amended by Public Law 92-500 and Executive Order 11738, grants, subgrants or contracts cannot be entered into, reviewed or extended with parties convicted of offenses under these laws.
- b. Relocation Provisions. In accordance with the provisions of the Uniform Relocation Assistance and Real Property Acquisition Policies Act of 1970, P.L. 91-646, 84 Stat. 1894, and the regulations of the Department of Justice (effective edition of LEAA Guideline G 4061.1, Relocation Assistance and Payments):
 - (1) The applicant and State Planning Agency shall assure that any program under which LEAA financial assistance is to be used to pay all or part of the cost of any program or project which results in displacement of any individual family, business and/or farm shall provide that:
 - (a) Within a reasonable period of time prior to displacement comparable decent, safe, and sanitary replacement dwellings will be available to displaced persons in accordance with such regulations as issued by the Attorney General;

M 4500.1G
September 30, 1978

- (b) Fair and reasonable relocation payments and assistance shall be provided to or for displaced persons as are required in such regulations as are issued by the Attorney General;
 - (c) Relocation or assistance programs shall be provided for such persons in accordance with such regulations issued by the Attorney General;
 - (d) The affected persons will be adequately informed of the available benefits and policies and procedures relating to the payment of monetary benefits; and
- (2) Such assurances shall be accompanied by an analysis of the relocation problems involved and a specific plan to resolve such problems.

c. Environmental Impact.

- (1) The National Environmental Policy Act of 1969 established environmental review procedures to determine if a proposed LEAA funded program or project is a "major Federal action significantly affecting the human environment." Each proposed action listed below must include an environmental evaluation.
- (a) New construction.
 - (b) The renovation or modification of a facility which leads to an increased occupancy of more than 25 persons.
 - (c) The implementation of programs involving the use of pesticides and other harmful chemicals.
 - (d) The implementation of programs involving harmful radiation (x-rays, etc.).
 - (e) Research and technology whose anticipated or intended future application could be expected to have a potential effect on the environment.
 - (f) Other actions determined by LEAA to possibly have a significant effect on the quality of the environment.

M 4500.1G

September 30, 1978

- (2) A determination shall thereafter be made by the responsible Federal official as to whether the action will have a significant effect on the environment requiring the preparation of an environmental analysis (a draft environmental impact statement) or whether a negative declaration can be filed.
 - (3) An environmental evaluation is a report of the environmental effects of the proposal and should consist of questions and narrative answers as well as supporting documentation that substantiates conclusions.
 - (4) An environmental analysis must be submitted with the original application in cases where the proposed action would significantly affect the environment. It will be utilized in the preparation of a draft environmental impact statement.
 - (5) A negative declaration will be filed by LEAA if the environmental evaluation does not indicate a significant environmental impact.
 - (6) Environmental Analysis Impact and Negative Declaration forms are available from Grants and Contracts Management Division, Law Enforcement Assistance Administration, 633 Indiana Avenue, Washington, D.C. 20531.
- d. Historic Sites. Before approving grants involving construction, renovation, purchasing or leasing of facilities LEAA shall consult with the State Liaison Officer for Historic Preservation to determine if the undertaking may have an effect on properties listed in the National Register of Historic Places. If the undertakings may have an effect on the listed properties, LEAA shall notify the Advisory Council on Historic Preservation.
- e. A-95 Notification Procedures. Applicants must notify appropriate areawide and State Clearinghouses of their intent to apply for Discretionary Grants, in accordance with LEAA's A-95 requirements (28CFR Part 30).
- f. Flood Disaster Protection Act of 1973, Pub. L. 93-234, 42 U.S.C. §4001, et seq. LEAA will not approve any financial assistance for construction purposes in any area that has been identified by the Secretary of HUD as an area having special flood hazards unless the community in the hazardous area is then participating in the National Flood Insurance Program.
- g. Rehabilitation. In accordance with the Rehabilitation Act of 1973 (P.L. 93-112), no otherwise qualified handicapped individual in the United States, as defined in Section 7(6) of that Act, shall, solely by reason of his handicap, be excluded from participation in, be denied the benefits of, or be subjected to discrimination under any program or activity receiving Federal financial assistance.

September 30, 1978

- h. Safe Drinking Water Act, Pub. L. 93-523, 42 U.S.C. §300f, et seq. If the Administrator of the Environmental Protection Agency determines that an area has an aquifer (a water-bearing stratum of permeable rock, sand or gravel) which is the sole or principal source of drinking water for an area, and which if contaminated would create a significant hazard to public health, he shall publish notice of that determination in the Federal Register. After publication of such notice, no commitment of Federal financial assistance (through a grant, contract, loan or otherwise) may be entered into for any project which the EPA Administrator determines may contaminate such an aquifer. Any prospective subgrantee of Parts C and E funds shall assure that the project will have no effect on an aquifer so designated by the EPA Administrator.
- i. Endangered Species Act of 1973, Pub. L. 93-205, 16 U.S.C. §1531, et seq. The Secretary of Interior shall publish in the Federal Register, and from time to time he may by regulations revise a list of species determined by him or the Secretary of Commerce to be endangered species and a list of all species determined by him or the Secretary of Commerce to be threatened species. Each list shall refer to the species contained therein by scientific and common name and shall specify with respect to each such specie over what portion of its range it is endangered or threatened. Any prospective recipient of LEAA funds shall certify in writing prior to a grant award that the proposed action will not jeopardize the continued existence of an endangered specie or a threatened specie or result in the destruction or modification of the habitat of such a specie.
- j. Wild and Scenic Rivers Act, Pub. L. 90-542, 16 U.S.C. §1271, et seq. LEAA must notify the Secretary of the Interior and, where National Forest lands are involved, the Secretary of Agriculture of any activities in progress, commenced or resumed which affect any of the rivers specified in the Wild and Scenic Rivers Act. Any prospective grantee or subgrantee of LEAA grant funds will certify in writing that LEAA will be notified if any of the designated rivers are or will be affected by any program or project.
- k. Fish and Wildlife Coordination Act, Pub. L. 85-624, 16 U.S.C. §661, et. seq. LEAA must notify the Fish and Wildlife Service of the Department of Interior and the head of the State administrative agency exercising administration over the wildlife resources of the State wherever the waters of any stream or other body of water are proposed to be diverted or controlled by LEAA, a grantee, or subgrantee. Any prospective recipient of LEAA grant funds will certify that LEAA will be notified if any of the actions specified in 16 U.S.C. §662(a) are anticipated.

M 4500.1G
September 30, 1978

- l. Historical and Archeological Preservation Act, Pub. L. 93-291, 16 U.S.C. §469, et seq. Any prospective recipient of LEAA funds shall notify LEAA if the funded activity may cause irreparable loss or destruction to significant historical or archeological data. LEAA will then notify the Secretary of the Interior who shall conduct a survey and investigation of the area which may be affected and recover and preserve such data.
- m. Coastal Zone Management Act of 1972, Pub. L. 92-583, 16 U.S.C. §1451, et seq. Each LEAA-supported activity which directly affects the Coastal Zone shall be conducted in a manner, which to the maximum extent feasible, is consistent with the approved State management program for the protection of the Coastal Zone. Every applicant submitting an application for grant funds supporting programs affecting land or water uses in the Coastal Zone shall attach the views of the appropriate State or local agencies on the relationship of the proposed activity to the approved management program. This applies to subgrant applications submitted to the State planning agency as well as to discretionary grant applications. Such applications shall be submitted in accordance with the provisions of Title IV of the Intergovernmental Cooperation Act of 1968, Pub. L. 90-577.
- n. Animal Welfare Act of 1970, Pub. L. 91-579, 7 U.S.C. §2131, et seq. This act establishes recordkeeping and animal treatment standards for schools, institutions, organizations and persons that use or intend to use live animals in research, tests or experiments, and that receive Federal funds for the purpose of carrying out research, tests or experiments. No grant or contract for this assures compliance with the provisions of the Animal Welfare Act of 1970.
- o. Criminal Penalties.
 - (1) Whoever embezzles, willfully misapplies, steals, or obtains by fraud or endeavors to embezzle, willfully misapply steal or obtain by fraud any funds, assets, or property which are the subject of a grant or contract or other form of assistance pursuant to this title, whether received directly or indirectly from the Administration, or whoever receives, conceals, or retains such funds, assets, or property with intent to convert such funds, assets, or property to his use or gain, knowing such funds, assets, or property have been embezzled, willfully misapplied, stolen, or obtained by fraud, shall be fined not more than \$10,000 or imprisoned not more than five years, or both.

App 1 Par 12
Page 14

ADD28

M 4500.1G
September 30, 1978

- (2) Whoever knowingly and willfully falsifies, conceals, or covers up by trick, scheme, or device, any material fact in any application for assistance submitted pursuant to the Act or in any records required to be maintained pursuant to the Act shall be subject to prosecution under the provisions of Section 1001 of Title 18, United States Code.
- (3) Any law enforcement and criminal justice program or project underwritten, in whole or in part, by any grant or contract or other form of assistance pursuant to the Act, whether received directly or indirectly from the Administration, shall be subject to the provisions of Section 371 of Title 18, United States Code.

SECTION 4. PROHIBITIONS AND RESTRICTIONS

13. LETHAL WEAPONS, AMMUNITION AND RELATED ITEMS. LEAA Discretionary Funds may not be used to purchase lethal weapons, ammunition, armored vehicles, explosive devices, and related items.
14. MEDICAL RESEARCH AND PSYCHOTHERAPY. LEAA discretionary funds may not be used for medical research or for the use of medical procedures which seek to modify behavior by means of any aspect of psychosurgery, aversion therapy, chemotherapy (except as part of routine clinical care), and physical therapy of mental disorders. Such proposals should be submitted to the Secretary of the Department of Health, Education and Welfare for funding consideration. This policy does not apply to programs involving procedures generally recognized and accepted as not subjecting the patient to physical or psychological risk (e.g., methadone maintenance and certain alcoholism treatment programs), specifically approved in advance by the Office of the Administration, LEAA, or to programs of behavior modification which involve environmental changes or social interaction where no medical procedures are utilized.
15. EXPENDITURES FOR PERSONNEL.
 - a. Not more than one-third of any discretionary grant may be expended for compensation of police or other regular law enforcement and criminal justice personnel, exclusive of time engaged in training programs or in research, development, demonstration, or other short term programs.
 - b. Indian manpower projects not exceeding 24 months duration are excepted from this restriction.

**U.S. DEPARTMENT OF JUSTICE
LAW ENFORCEMENT ASSISTANCE ADMINISTRATION
WASHINGTON, D.C. 20531**

**OFFICIAL BUSINESS
PENALTY FOR PRIVATE USE, \$300**

**POSTAGE AND FEES PAID
U.S. DEPARTMENT OF JUSTICE
JUS-436**



**SPECIAL FOURTH-CLASS RATE
BOOK**

PUBLIC LAW 96-157--DEC. 27, 1979

93 STAT. 1167

Public Law 96-157
96th Congress

An Act

To restructure the Federal Law Enforcement Assistance Administration, to assist State and local governments in improving the quality of their justice systems, and for other purposes.

Dec. 27, 1979
[S. 241]

Be it enacted by the Senate and House of Representatives of the United States of America in Congress assembled, That this Act may be cited as the "Justice System Improvement Act of 1979".

Justice System
Improvement
Act of 1979.
42 USC 3701
note.

SEC. 2. Title I of the Omnibus Crime Control and Safe Streets Act of 1968 is amended to read as follows:

"TITLE I—JUSTICE SYSTEM IMPROVEMENT

"TABLE OF CONTENTS

"Declaration and purpose.

"PART A—LAW ENFORCEMENT ASSISTANCE ADMINISTRATION

- "Sec. 101. Establishment of Law Enforcement Assistance Administration.
- "Sec. 102. Duties and functions of Administrator.
- "Sec. 103. Office of Community Anti-Crime Programs.

"PART B—NATIONAL INSTITUTE OF JUSTICE

- "Sec. 201. National Institute of Justice.
- "Sec. 202. Establishment, duties, and functions.
- "Sec. 203. Authority for 100 per centum grants.
- "Sec. 204. National Institute of Justice Advisory Board.

"PART C—BUREAU OF JUSTICE STATISTICS

- "Sec. 301. Bureau of Justice Statistics.
- "Sec. 302. Establishment, duties, and functions.
- "Sec. 303. Authority for 100 per centum grants.
- "Sec. 304. Bureau of Justice Statistics Advisory Board.
- "Sec. 305. Use of data.

"PART D—FORMULA GRANTS

- "Sec. 401. Description of program.
- "Sec. 402. Eligibility.
- "Sec. 403. Applications.
- "Sec. 404. Review of applications.
- "Sec. 405. Allocation and distribution of funds.

"PART E—NATIONAL PRIORITY GRANTS

- "Sec. 501. Purpose.
- "Sec. 502. Percentage of appropriation for national priority grant program.
- "Sec. 503. Procedure for designating national priority programs.
- "Sec. 504. Application requirements.
- "Sec. 505. Criteria for award.

"PART F—DISCRETIONARY GRANTS

- "Sec. 601. Purpose.
- "Sec. 602. Percentage of appropriation for discretionary grant program.

PUBLIC LAW 96-157—DEC. 27, 1979

93 STAT. 1187

“(f) To be eligible for funds under this part all eligible jurisdictions shall assure the participation of citizens, and neighborhood and community organizations, in the application process. No grant may be made pursuant to this part unless the eligible jurisdiction has provided satisfactory assurances to the Administration that the applicant has—

Funds, eligibility.

“(1) provided citizens and neighborhood and community organizations with adequate information concerning the amounts of funds available for proposed programs or projects under this title, the range of activities that may be undertaken, and other important program requirements;

“(2) provided citizens and neighborhood and community organizations an opportunity to consider and comment on priorities set forth in the application or amendments;

“(3) provided for full and adequate participation of units of local government in the performance of the analysis and the establishment of priorities required by subsection (b)(1)(A); and

“(4) provided an opportunity for all affected criminal justice agencies to consider and comment on the proposed programs to be set forth in the application or amendments.

The Administrator, in cooperation with the Office of Community Anti-Crime Programs, may establish such rules, regulations, and procedures as are necessary to assure that citizens and neighborhood and community organizations will be assured an opportunity to participate in the application process.

Application process, rules.

“APPLICATIONS

“Sec. 403. (a) No grant may be made by the Administration to a State, or by a State to an eligible recipient pursuant to part D, unless the application sets forth criminal justice programs covering a three-year period which meet the objectives of section 401 of this title. This application must be amended annually if new programs are to be added to the application or if the programs contained in the original application are not implemented. The application must include—

42 USC 3743.

“(1) an analysis of the crime problems and criminal justice needs within the relevant jurisdiction and a description of the services to be provided and performance goals and priorities, including a specific statement of how the programs are expected to advance the objectives of section 401 of this title and meet the identified crime problems and criminal justice needs of the jurisdiction;

Contents.

“(2) an indication of how the programs relate to other similar State or local programs directed at the same or similar problems;

“(3) an assurance that following the first fiscal year covered by an application and each fiscal year thereafter, the applicant shall submit to the Administration, where the applicant is a State, and to the council where the applicant is a State agency, the judicial coordinating committees, a nongovernmental grantee, or a unit or combination of units of local government—

“(A) a performance report concerning the activities carried out pursuant to this title; and

“(B) an assessment by the applicant of the impact of those activities on the objectives of this title and the needs and objectives identified in the applicant’s statement;

“(4) a certification that Federal funds made available under this title will not be used to supplant State or local funds, but will be used to increase the amounts of such funds that would, in the

93 STAT. 1188

PUBLIC LAW 96-157—DEC. 27, 1979

absence of Federal funds, be made available for criminal justice activities;

“(5) an assurance where the applicant is a State or unit or combination of units of local government that there is an adequate share of funds for courts and for corrections, police, prosecution, and defense programs;

“(6) a provision for fund accounting, auditing, monitoring, and such evaluation procedures as may be necessary to keep such records as the Administration shall prescribe to assure fiscal control, proper management, and efficient disbursement of funds received under this title;

“(7) a provision for the maintenance of such data and information and for the submission of such reports in such form, at such times, and containing such data and information as the Administration may reasonably require to administer other provisions of this title;

“(8) a certification that its programs meet all the requirements of this section, that all the information contained in the application is correct, that there has been appropriate coordination with affected agencies, and that the applicant will comply with all provisions of this title and all other applicable Federal laws. Such certification shall be made in a form acceptable to the Administration and shall be executed by the chief executive officer or other officer of the applicant qualified under regulations promulgated by the Administration; and

“(9) satisfactory assurances that equipment, whose purchase was previously made in connection with a program or project in such State assisted under this title and whose cost in the aggregate was \$100,000 or more, has been put into use not later than one year after the date set at the time of purchase for the commencement of such use and has continued in use during its useful life.

“(b) Applications from judicial coordinating committees, State agencies, and other nongovernmental grantees do not have to include the crime analysis required by subsection (a)(1) but may rely on the crime analysis prepared by the council.

“REVIEW OF APPLICATIONS

Financial assistance.
42 USC 3744.

“SEC. 404. (a) The Administration shall provide financial assistance to each State applicant under this part to carry out the programs or projects submitted by such applicant upon determining that—

“(1) the application or amendment thereof is consistent with the requirements of this title;

“(2) the application or amendment thereof was made public prior to submission to the Administration and an opportunity to comment thereon was provided to citizens and neighborhood and community groups; and

“(3) prior to the approval of the application or amendment thereof the Administration has made an affirmative finding in writing that the program or project is likely to contribute effectively to the achievement of the objectives of section 401 of this title.

Each application or amendment made and submitted for approval to the Administration pursuant to section 403 of this title shall be deemed approved, in whole or in part, by the Administration within ninety days after first received unless the Administration informs the applicant of specific reasons for disapproval.

LEAA

GENERAL BRIEFING

FEBRUARY 1977



**LAW ENFORCEMENT ASSISTANCE ADMINISTRATION
U.S. DEPARTMENT OF JUSTICE**

BASIS OF LEGISLATION

- **CRIME A LOCAL PROBLEM/BEST CONTROLLED AT STATE AND LOCAL LEVEL**
- **LAW ENFORCEMENT AUTHORITY TRADITIONALLY RESERVED TO STATES (CONCEPTS OF FEDERALISM)**
- **LEAA NOT ESTABLISHED AS AN OPERATIONAL LAW ENFORCEMENT AGENCY**
- **NO LEAA DIRECTION, SUPERVISION OR CONTROL OVER STATE OR LOCAL LAW ENFORCEMENT AGENCIES - [SECTION 518 (a)]**

LEAA PROGRAM PURPOSES

- **ENCOURAGE STATE COMPREHENSIVE PLANNING FOR CRIMINAL JUSTICE IMPROVEMENTS**
- **TECHNICAL AND FINANCIAL ASSISTANCE TO IMPROVE & STRENGTHEN LAW ENFORCEMENT & CRIMINAL JUSTICE**
- **CONDUCT RESEARCH & DEVELOPMENT TO IMPROVE CRIMINAL JUSTICE**
- **DEVELOP & TRANSFER NEW TECHNIQUES AND METHODS TO:**
 - **REDUCE CRIME**
 - **DETECT, APPREHEND, AND REHABILITATE CRIMINALS**

PROGRAMS

BLOCK GRANTS FOR:

- **CRIMINAL JUSTICE PLANNING, EVALUATION, ADMINISTRATION & TECHNICAL ASSISTANCE**
- **CRIMINAL JUSTICE SYSTEM IMPROVEMENTS (POLICE, COURTS, CORRECTIONS)**
- **CORRECTIONAL PROGRAM IMPROVEMENTS**
- **JUVENILE JUSTICE AND DELINQUENCY PREVENTION**

PROGRAMS

DIRECT GRANTS AND CONTRACTS FOR:

- **CRIMINAL JUSTICE SYSTEM IMPROVEMENTS
(POLICE, COURTS, CORRECTIONS)**
- **EDUCATIONAL ASSISTANCE**
- **TECHNICAL ASSISTANCE**
- **INFORMATION SYSTEMS AND STATISTICS**
- **JUVENILE JUSTICE & DELINQUENCY PREVENTION**
- **RESEARCH & EVALUATION**
- **COMMUNITY ANTI-CRIME PROGRAMS**

PUBLIC SAFETY OFFICERS' BENEFIT ACT (PSOB)

COLLATERAL RESPONSIBILITIES

- **CIVIL RIGHTS COMPLIANCE**
- **PRISON/JAIL CONSTRUCTION GUIDELINES**
- **PRIVACY AND SECURITY OF CRIMINAL JUSTICE INFORMATION AND STATISTICS SYSTEMS**
- **NATIONAL ENVIRONMENTAL POLICY COMPLIANCE**
- **JOINT FUNDING SIMPLIFICATION ACT**
- **INTERGOVERNMENTAL COOPERATION ACT (A-95)**
- **SURPLUS PROPERTY MANAGEMENT**
- **FREEDOM OF INFORMATION COMPLIANCE**

PLUS 23 OTHER APPLICABLE ACTS

INTERGOVERNMENTAL DELIVERY SYSTEM

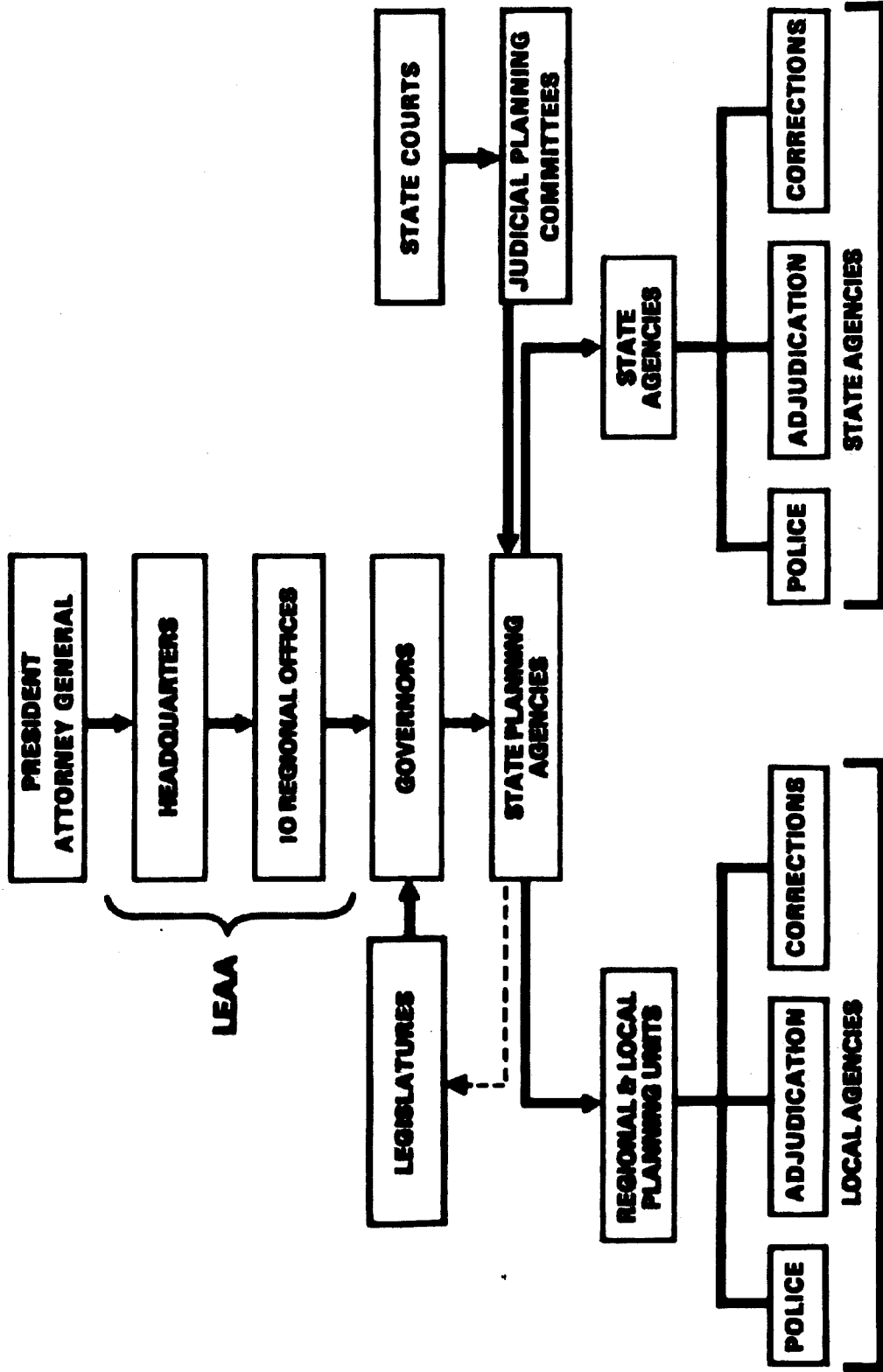

COMPARISON OF: LEAA 1968 ACT AND 1968 ACT AS AMENDED

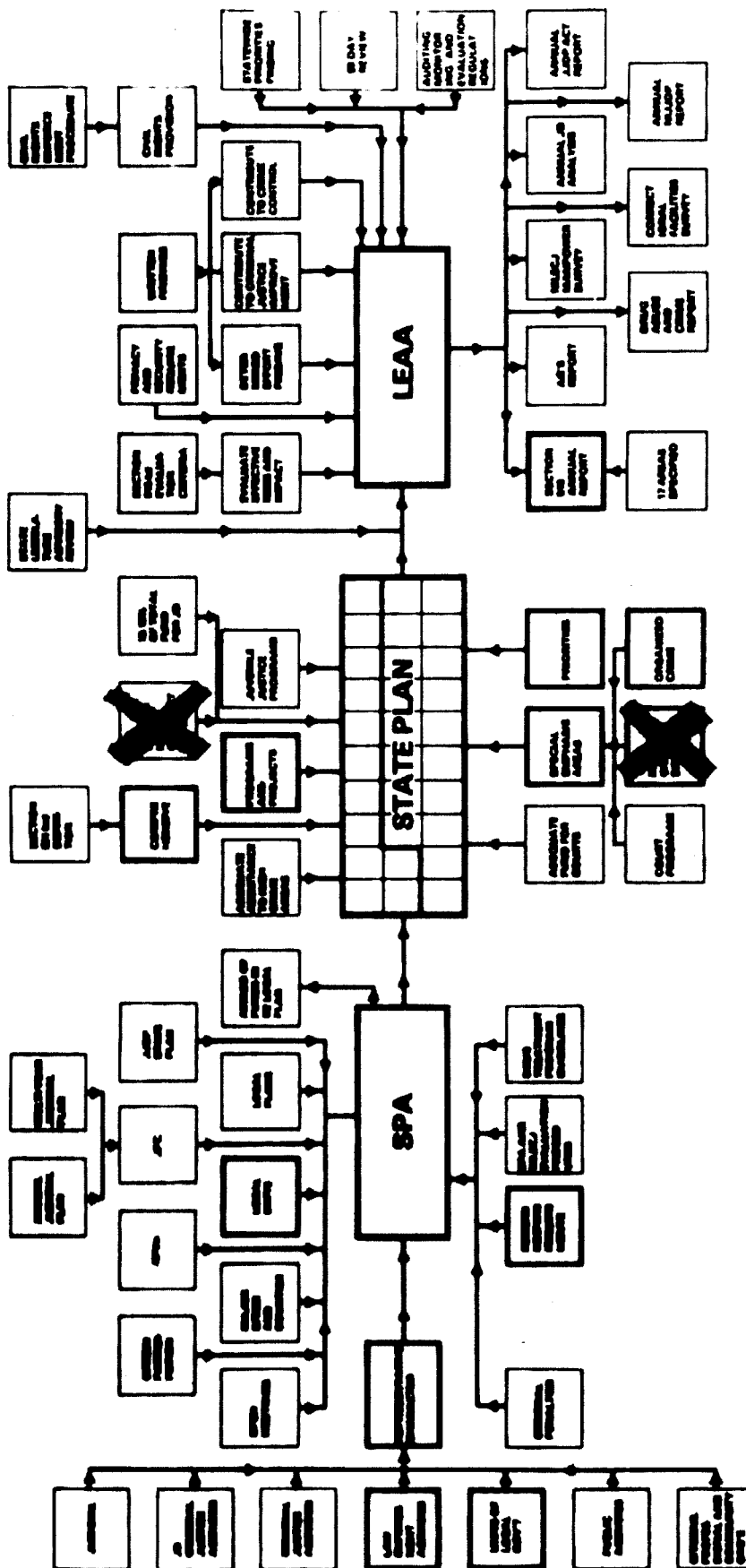

LEAA ORGANIZATION CHART

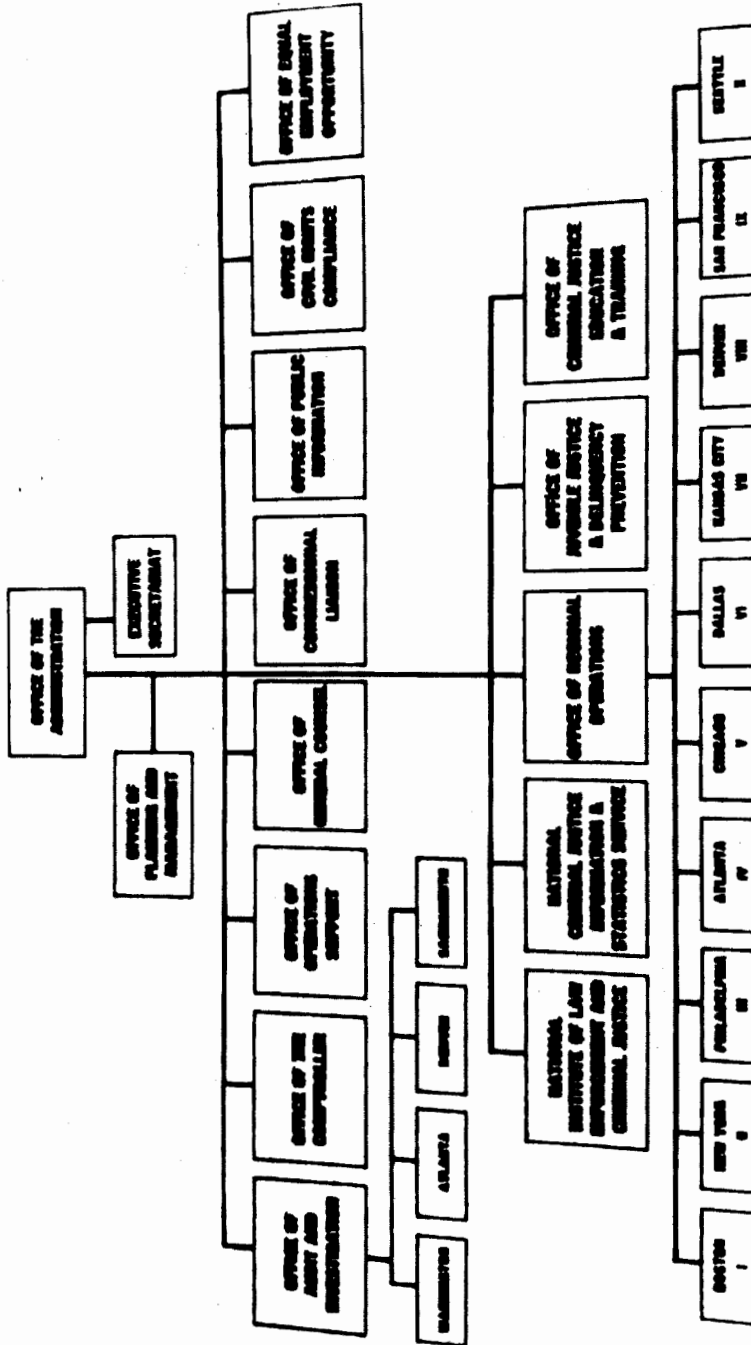

PRIORITIES

- **INCARCERATE SERIOUS HABITUAL OFFENDERS**
- **IMPROVE COURT MANAGEMENT AND REDUCE COURT DELAY**
- **PREVENT JUVENILE DELINQUENCY**
- **OBTAIN BETTER CRIMINAL JUSTICE STATISTICS**
- **UPGRADE JAILS AND PRISONS**
- **DISRUPT CRIMINAL OPERATIONS (e.g. STING)**
- **INTERVENE IN CRIMINAL CAREERS**
- **EVALUATE IMPACT OF FUNDED PROJECTS**
- **TRAIN & EDUCATE CRIMINAL JUSTICE PERSONNEL**
- **REPLICATE SUCCESSFUL PROJECTS**
- **EVALUATE TRADITIONAL CRIMINAL JUSTICE PRACTICES**
- **IMPROVE STATE/LOCAL ANALYSIS & EVALUATION CAPABILITY**
- **PROVIDE TECHNICAL ASSISTANCE**
- **ENCOURAGE DEVELOPMENT OF STANDARDS & GOALS FOR CRIMINAL JUSTICE**

ORGANIZED CRIME PROGRAM ANNUAL BUDGET
\$7.9 M

PURPOSE:

IMPROVE INVESTIGATIVE AND PROSECUTORIAL EFFORTS THROUGH OPERATIONS, TECHNICAL ASSISTANCE AND TRAINING.

TARGET GROUP:

ORGANIZED CRIMINALS AND MAJOR CRIMINAL CONSPIRACIES

KEY FEATURES:

● **IDENTIFICATION OF ORGANIZED CRIMINAL ACTIVITY TO INCLUDE FENCING, WHITE COLLAR CRIME, CORRUPTION AND CARGO THEFT**

● **INVESTIGATION, PROSECUTION AND REMOVAL OF ORGANIZED CRIMINALS**

● **INTERGOVERNMENTAL COOPERATION AMONG LOCAL, STATE AND FEDERAL AGENCIES**

RESULTS:

● **\$24 M RECOVERED IN STOLEN PROPERTY - (\$4.5 M BUY MONEY)**

● **70% ARRESTED ARE CAREER CRIMINALS**

● **369 CONVICTIONS FROM 10 ANTI-FENCING PROJECTS -- 75% GUILTY PLEAS**

ORGANIZED CRIME

PROGRAM RESULTS *

ANTI-FENCING -- (SINCE FY 74)

GENERAL -- (SINCE FY 68)

NO. OF PROJECTS	28	NO. OF PROJECTS	295
NO. OF ARRESTS/ CHARGES	748	NO. OF INVESTIGATORS AND PROSECUTORS TRAINED	
STOLEN PROPERTY RECOVERED	↑ 24 MILLION	NO. OF STATE ORGANIZED CRIME PREVENTION COUNCILS	12
CRIMINAL PROFILE	76% CAREER CRIMINAL	NO. OF MANUALS PRODUCED	15
CONVICTIONS	368	NO. OF INVESTIGATIONS	29,000
TYPE OF CON- VICTIONS	75% GUILTY PLEAS	NO. OF ARRESTS	8,000
SAVINGS	SIGNIFICANT PROSECUTORIAL AND JUDICIAL RESOURCES	NO. OF CONVICTIONS	800

* RESULTS OF PHASE ONE OF 10 PROJECTS

ORGANIZED CRIME

PROGRAM RESULTS ★

ANTI-FENCING -- (SINCE FY 74)

GENERAL -- (SINCE FY 68)

NO. OF PROJECTS	28	NO. OF PROJECTS	285
NO. OF ARRESTS/ CHARGES	748	NO. OF INVESTIGATORS AND PROSECUTORS TRAINED	
STOLEN PROPERTY RECOVERED	\$ 24 MILLION	NO. OF STATE ORGANIZED CRIME PREVENTION COUNCILS	12
CRIMINAL PROFILE	78% CAREER CRIMINAL	NO. OF MANUALS PRODUCED	15
CONVICTIONS	388	NO. OF INVESTIGATIONS	20,000
TYPE OF CON- VICTIONS	78% GUILTY PLEAS	NO. OF ARRESTS	8,000
SAVINGS	SIGNIFICANT PROSECUTORIAL AND JUDICIAL RESOURCES	NO. OF CONVICTIONS	800

★ RESULTS OF PHASE ONE OF 10 PROJECTS

ORGANIZED CRIME

PROGRAM RESULTS *

ANTI-FENCING -- (SINCE FY 74)

GENERAL -- (SINCE FY 60)

NO. OF PROJECTS	28	NO. OF PROJECTS	205
NO. OF ARRESTS/ CHARGES	748	NO. OF INVESTIGATORS AND PROSECUTORS TRAINED	
STOLEN PROPERTY RECOVERED	↑ 24 MILLION	NO. OF STATE ORGANIZED CRIME PREVENTION COUNCILS	12
CRIMINAL PROFILE	70% CAREER CRIMINAL	NO. OF MANUALS PRODUCED	15
CONVICTIONS	368	NO. OF INVESTIGATIONS	20,000
TYPE OF CON- VICTIONS	76% GUILTY PLEAS	NO. OF ARRESTS	8,000
SAVINGS	SIGNIFICANT PROSECUTORIAL AND JUDICIAL RESOURCES	NO. OF CONVICTIONS	800

* RESULTS OF PHASE ONE OF 10 PROJECTS

ANNUAL BUDGET
\$6.8 M

CAREER CRIMINAL PROGRAM

PURPOSE:

TO PROSECUTE REPEAT OFFENDERS

TARGET GROUP:

THE VIOLENT AND REPEAT OFFENDER

KEY FEATURES:

- **IDENTIFICATION:
PROMPT SELECTION OF DEFENDANTS DESERVING
OF FULL AND BEST APPLICATION OF PROSECUTORIAL
RESOURCES.**
- **PRIORITY:
PROSECUTION BY EXPERIENCED PROSECUTORS WITH
APPEARANCES AT EVERY STAGE OF ADJUDICATORIAL
PROCESS, THROUGH SENTENCING**
- **RESULTS:
93.8% CONVICTION RATE, 19.41 YEARS AVERAGE
SENTENCE**

CAREER CRIMINAL PROGRAM

PROGRAM RESULTS -- AS OF DEC. 13, 1976

- **19 DISCRETIONARY FUNDED PROJECTS**
- **3,445 DEFENDANT DISPOSITIONS**
- **3,231 DEFENDANT CONVICTIONS**
- **93.8% CONVICTION OF DISPOSITION**
- **93.2% INCARCERATION RATE OF DEFENDANTS CONVICTED**
- **19.41 YEARS AVERAGE SENTENCE**
- **86 DAYS MEDIAN TIME FROM ARREST TO SENTENCE**
- **CONVICTED DEFENDANTS PRIOR CRIMINAL RECORD**
 - **32,005 PRIOR ARRESTS**
 - **AVERAGE 10 PER DEFENDANT**
 - **17,170 PRIOR CONVICTIONS**
 - **AVERAGE 5.5 PER DEFENDANT**
- **44.3% CONVICTED DEFENDANT'S STATUS AT TIME OF ARREST (REARREST) i.e., ON PROBATION, PAROLE, PRETRIAL RELEASE OR AN ESCAPEE.**

STANDARDS AND GOALS

PURPOSE:

TO RECOMMEND STANDARDS FOR USE BY STATES AND LOCALITIES IN CONTROLLING CRIME AND IMPROVING THEIR CRIMINAL JUSTICE SYSTEMS.

● **REPORTS ISSUED:**

PHASE I

- **NATIONAL STRATEGY TO REDUCE CRIME**
 - **POLICE**
 - **COURTS**
 - **CORRECTIONS**
 - **COMMUNITY CRIME PREVENTION**
 - **CRIMINAL JUSTICE SYSTEM**

PHASE II

- **ORGANIZED CRIME**
- **DISORDERS AND TERRORISM**
- **JUVENILE JUSTICE**
- **PRIVACY & SECURITY**
- **RESEARCH AND DEVELOPMENT**

- **STATES ENCOURAGED TO REVIEW AND ADOPT OWN STANDARDS**

STANDARDS AND GOALS (PHASE I)

PURPOSE:

TO RECOMMEND STANDARDS FOR USE BY STATES AND LOCALITIES IN CONTROLLING CRIME AND IMPROVING THEIR CRIMINAL JUSTICE SYSTEMS.

PHASE I

- NATIONAL ADVISORY COMMISSION ESTABLISHED IN 1971
- NATIONAL ADVISORY COMMISSION ADOPTS OVER 500 SPECIFIC RECOMMENDATIONS SETTING PERFORMANCE LEVELS FOR OPERATION OF THE ENTIRE CRIMINAL JUSTICE SYSTEM.
- SIX-VOLUME REPORT ISSUED IN 1973
 - POLICE — COMMUNITY CRIME PREVENTION
 - COURTS — CRIMINAL JUSTICE SYSTEM
 - CORRECTIONS — NATIONAL STRATEGY TO REDUCE CRIME
- 30,000 COPIES DISTRIBUTED OR SOLD (EACH)
- STATES ENCOURAGED TO REVIEW AND ADOPT OWN STANDARDS
- BY 1976 ALL STATES HAD STANDARDS AND GOALS REVIEW EFFORTS AND 35 IMPLEMENTING STANDARDS
- EVALUATION NOW UNDERWAY

STANDARDS AND GOALS (PHASE II)

- **NATIONAL ADVISORY COMMITTEE — FORMED IN 1975**
- **CHAired BY GOVERNOR BRENDAN T. BYRNE**
- **STANDARDS ADOPTED IN:**
 - **ORGANIZED CRIME**
 - **JUVENILE JUSTICE**
 - **DISORDERS AND TERRORISM**
 - **PRIVACY SECURITY**
 - **RESEARCH AND DEVELOPMENT**
- **ORGANIZED CRIME AND RESEARCH AND DEVELOPMENT VOLUMES NOW AVAILABLE**
- **REMAINING THREE AVAILABLE BY END OF FEBRUARY 1977**

ANNUAL BUDGET
\$4.6 M

**TREATMENT ALTERNATIVE TO STREET CRIME
(TASC)**

**PURPOSE: TO REDUCE DRUG-RELATED CRIME BY REFERRING
OFFENDERS INTO TREATMENT**

TARGET GROUP: DRUG ABUSING CRIMINAL OFFENDERS

- KEY FEATURES:**
- **REDUCES PROCESSING BURDENS**
 - **IMPROVES COOPERATION BETWEEN CRIMINAL
JUSTICE AND TREATMENT SYSTEMS**
 - **REDUCES SPREAD OF DRUG ABUSE**

- RESULTS:**
- **72% OF 28,500 CLIENTS SUCCESSFULLY COMPLETED
PROGRAM**
 - **ONLY 11% REARRESTED – 2% CONVICTED**

**TREATMENT ALTERNATIVES TO STREET CRIME (TASC)
PROGRAM RESULTS AS OF JANUARY 1, 1977**

CLIENTS ENTERING TASC:

- **39 PROJECTS**
- **28,500 CLIENTS FORMALLY REFERRED TO AND/OR OFFICIALLY ADMITTED TO PROJECTS**
- **5,100 CLIENTS ACTIVE TODAY**
- **28% OF CLIENTS DROPPED OUT OR FAILED TASC REQUIREMENTS**
- **11% OF CLIENTS REARRESTED WHILE IN PROGRAM, 2% CONVICTED**
- **4,900 CLIENTS SUCCESSFULLY COMPLETED TASC PROGRAM REQUIREMENTS**

FY 77 BUDGET
\$12 M

COURT IMPROVEMENT INITIATIVES

PURPOSE: TO IMPROVE COURT MANAGEMENT

TARGET GROUPS: STATE COURTS, TRIAL COURTS

KEY FEATURES: ● TECHNICAL ASSISTANCE TO JUDGES, PROSECUTORS, COURT ADMINISTRATORS

● INTRODUCTION OF ADVANCED PLANNING TECHNIQUES

● REDUCE PRE-TRIAL DELAY

● ACQUIRE DATA ON CASELOAD, PROCESSING TIMES

RESULTS: ● 44 STATES DOING LONG-RANGE PLANNING

● UNIFIED COURT SYSTEMS DOUBLED

● SUPPORT FOR:

- NATIONAL CENTER FOR STATE COURTS
- NATIONAL CENTER FOR DEFENSE MANAGEMENT
- NATIONAL ASSOCIATION OF ATTORNEYS GENERAL
- INSTITUTE FOR COURT MANAGEMENT

ADJUDICATION TECHNICAL ASSISTANCE PROGRAM RESULTS

SUMMARY DATA

- 1. TRAINING**
 - PROSECUTORS -- 1,500 ● TRIAL ADVOCATES -- 300
 - DEFENSE COUNSEL -- 1,000 ● PRETRIAL AGENCY
PERSONNEL -- 360
 - APPELLATE JUDGES -- 240
 - OTHER JUDGES -- 6,000 ● COURT ADMINISTRATORS -- 220

- 2. TECHNICAL ASSISTANCE STUDIES COMPLETED**
 - DEFENSE -- 30 ● PROSECUTION -- 60 ● COURTS -- 90

- 3. OTHER RESULTS**
 - PRE-APPEAL SETTLEMENT CONFERENCES IN STATE COURT
 - IMPROVED COURT MANAGEMENT
 - SCREENING STAFF FOR STATE APPELLATE COURTS
 - 50 JURISDICTIONS USING THE PROSECUTORS
MANAGEMENT INFORMATION SYSTEM (PROMIS)

PRETRIAL DELAY REDUCTION

(NEW PROGRAM)

PURPOSE: REDUCE PRETRIAL DELAY

TARGET GROUP: TRIAL COURTS

- KEY FEATURES:**
- 1. ACCURATELY ASSESS STATE OF DELAY THROUGHOUT COUNTRY**
 - 2. ACCUMULATE INFORMATION ON ALL PROGRAMS AND TECHNIQUES USED AROUND THE COUNTRY TO REDUCE PRETRIAL DELAY**
 - 3. BEGIN INTENSIVE APPLICATION OF BEST KNOW METHODS IN SIX TEST JURISDICTIONS.**
 - 4. BEGIN JURISTITION -- WIDE TESTS OF 6-10 NEW APPROACHES TO DELAY -- REDUCTION**
 - 5. CONTINUOUS PROGRAM OVERSIGHT BY LEAA COURTS WORKING GROUPS (RESEARCH, STATISTICS, ACTION, MANAGEMENT DIVISION REPRESENTATIVES)**
 - 6. NATION-WIDE JUDICIAL STATISTICS PROGRAM INITIATED**
 - 7. STATE SPEEDY TRIAL ANALYSIS AND RECOMMENDATIONS**
- OBJECTIVE: TO REDUCE TIME FROM ARREST TO TRIAL TO 60 DAYS IN 18 TRIAL COURTS.**

**PROSECUTOR'S MANAGEMENT
INFORMATION SYSTEM (PROMIS)**

**ANNUAL BUDGET
\$ 5 M**

PURPOSE: TO APPLY ADVANCED BUSINESS MANAGEMENT TO PROSECUTOR COURT SCHEDULING AND CASE HANDLING.

TARGET GROUP: PROSECUTORS AND COURTS

- KEY FEATURES:**
- CONTROL OF SCHEDULING AND ALLOTMENT OF PROSECUTION RESOURCES
 - TIMELY ACCESS TO CASE STATUS INFORMATION
 - ANALYSIS OF PROBLEMS ASSOCIATED WITH PROSECUTION/COURT ACTIVITIES AND PROCEDURES
 - COLLECTION OF DATA CONCERNING ACCUSED PERSONS, CRIME, ARRESTS, WITNESSES
 - 25% INCREASE IN CONVICTION RATES, TIME CUT 50%
 - OPERATIONAL OR PLANNED IN JURISDICTIONS COVERING 21% OF NATION

PROMIS

PROGRAM RESULTS:

- PROMIS OPERATIONAL OR PLANNED IN JURISDICTIONS COMPRISING 21% OF THE U.S. POPULATION
- 25% INCREASE IN CONVICTION RATE IN SERIOUS CASES
- TIME LAG BEFORE INDICTMENT CUT 50%
- PROMPT IDENTIFICATION OF OFFENDERS WITH OTHER CASES PENDING
- DEFICIENCIES IN CASE DOCUMENTATION AND PROSECUTION SKILLS IDENTIFIED THROUGH PROMIS
- UNIFORMITY OF STATISTICS ESTABLISHED AMONG PROMIS USERS FOR CROSS JURISDICTIONAL ANALYSIS
- PROMIS USER GROUP: FORUM FOR INFORMATION EXCHANGE.

FY 77 BUDGET
\$10.5 M

CORRECTIONS

- PURPOSE:** TO PROVIDE FOR MORE EFFECTIVE CORRECTIONAL SYSTEMS
- TARGET GROUP:** STATE AND LOCAL CORRECTIONAL AGENCIES INCLUDING JAILS, INSTITUTIONS, PROBATION AND PAROLE
- KEY FEATURES:** PROVIDES SUPPORT FOR:
1. STATE-WIDE CORRECTIONS MASTERPLANNING
 2. CORRECTIONAL OFFICER TRAINING
 3. MEDICAL CARE/HEALTH SERVICES DELIVERY SYSTEMS
 4. EXPERIMENTS IN RESTITUTION
 5. IMPROVEMENTS IN PROBATION AND PAROLE SERVICES
 6. JAIL PROGRAMS (ALTERNATIVES, DIVERSION, AND MEDICAL SERVICES)
 7. CORRECTIONAL STANDARDS
 8. TECHNICAL ASSISTANCE NATIONWIDE

CORRECTIONS PROGRAM RESULTS FY 1977

28 PROJECTS OPERATIONAL

16 PROJECTS PLANNED

45 TOTAL PROJECTS FOR FY 1977

● TECHNICAL ASSISTANCE:

● 288 RESPONSES IN FY 77 TO REQUESTS FOR T.A.

● AREAS IN WHICH T.A. WAS PROVIDED:

- 1. EVALUATION AND RESEARCH**
- 2. PROGRAM DEVELOPMENT**
- 3. TRAINING**
- 4. CLIENT SERVICES**
- 5. PART E COMPLIANCE REVIEWS BY THE NATIONAL CLEARINGHOUSE FOR CRIMINAL JUSTICE PLANNING AND ARCHITECTURE**

● MEDICAL SERVICES

● PROMULGATION OF NATIONAL TRAINING DESIGN

● SITE TESTING OF MEDICAL SERVICES DESIGN IN 5 STATES

● PRISON INDUSTRIES

● NATIONAL TECHNICAL ASSISTANCE PROVIDED IN 3 STATES

● SITE TESTING OF MODEL IN 3 STATES

**LAW ENFORCEMENT EDUCATION PROGRAM
(LEEP)**

ANNUAL BUDGET
₱40 M

**PURPOSE: UPGRADE EDUCATIONAL ACHIEVEMENTS OF
CRIMINAL JUSTICE SYSTEM PERSONNEL**

**TARGET GROUP: PERSONNEL EMPLOYED BY OR SEEKING CAREERS
IN CRIMINAL JUSTICE AGENCIES**

- KEY FEATURES:**
- **PROVIDE GRANTS AND LOANS TO INDIVIDUALS**
 - **EXPAND CRIMINAL JUSTICE EDUCATION OPPORTUNITIES**
 - **UPGRADE QUALITY OF CURRICULUM**

LEEP

CURRENT YEAR

PARTICIPATING INSTITUTIONS	1,814
PARTICIPATING INDIVIDUALS	98,888 (TOTAL)
POLICE	78,888 (71.4%)
ADJUDICATION	5,888 (5.1%)
CORRECTIONS	11,888 (12%)
OTHER	4,200 (4.2%)
PRE-SERVICE	7,888 (7.1%)

CUMULATIVE ACTIVITY

FUNDING 1968-1977	\$221 MILLION
PARTICIPANTS	273,888
DEGREE OBJECTIVES	
2-YEAR (AA OR CERTIFICATE)	148,888
4-YEAR (BACHELOR OF ARTS)	97,888
GRADUATE LEVEL (MA, PhD)	38,888

SYSTEMS AND STATISTICS

SYSTEMS

- **STATE JUDICIAL INFORMATION SYSTEM (SJIS)**
- **PROSECUTOR'S MANAGEMENT INFORMATION SYSTEM (PROMIS)**
- **OFFENDER BASED STATE CORRECTIONAL INFORMATION SYSTEM (OBSCIS)**
- **NATIONAL LAW ENFORCEMENT TELECOMMUNICATIONS (NALECOM)**
- **APCO PROJECT 13 AND 13A -- COMMUNICATIONS PLANNING AND TECHNICAL ASSISTANCE**

STATISTICS

- **NATIONAL CRIME PANEL VICTIMIZATION SURVEY**
- **COMPREHENSIVE DATA SYSTEMS**
- **EMPLOYMENT AND EXPENDITURE SURVEY**
- **SOURCEBOOK OF CRIMINAL JUSTICE STATISTICS**
 - **PAROLE** — **FACILITIES**
 - **PRISONERS** — **COURT**
- **NATIONAL CRIMINAL JUSTICE DATA ARCHIVE NETWORK**

COMPREHENSIVE DATA SYSTEMS
(CDS)
FY 77 BUDGET
\$13 M

PURPOSE: TO ESTABLISH OR ENHANCE STATE LEVEL CRIMINAL JUSTICE INFORMATION AND STATISTICS CAPABILITIES.

TARGET GROUP: 50 STATES, THE DISTRICT OF COLUMBIA AND PUERTO RICO

- KEY FEATURES:**
- REQUIRE A STATE DATA SYSTEM ACTION PLAN
 - ESTABLISH STATE STATISTICAL ANALYSIS CENTERS (SACs)
 - STATE LEVEL RESPONSIBILITY FOR UNIFORM CRIME REPORTS (UCRs)
 - COMPUTERIZED CRIMINAL HISTORIES (CCH)
 - OFFENDER BASED TRANSACTION STATISTICS (OBTS)
 - BEING IMPLEMENTED IN 49 STATES

COMPREHENSIVE DATA SYSTEMS (CDS)

PROGRAM RESULTS:

- **40 STATES ARE IMPLEMENTING OR PREPARING TO IMPLEMENT A CDS PROGRAM**
- **38 STATES HAVE ESTABLISHED STATISTICAL ANALYSIS CENTERS**
- **IMPROVED ANALYTICAL INPUT TO STATE COMPREHENSIVE PLANS THROUGH SAC'S**
- **35 STATES REPORTING TO FBI'S UNIFORM CRIME REPORTS**
- **30 OFFENDER BASED TRANSACTION STATISTICS/ COMPUTERIZED CRIMINAL HISTORY SYSTEMS UNDER DEVELOPMENT.**

FY 77 BUDGET
\$6.7 M

VICTIMIZATION SURVEYS

PURPOSE:

TO OBTAIN INFORMATION CONCERNING BOTH REPORTED AND UNREPORTED CRIMINAL VICTIMIZATION.

KEY FEATURES:

- **SHOWS CHANGES IN RATES OF VICTIMIZATION OVER TIME**
- **CONTINUOUS SURVEYS IN 26 AMERICAN CITIES INVOLVING INTERVIEWS WITH 65,000 HOUSEHOLDS, 135,000 PERSONS AND 15,000 BUSINESSES EVERY SIX MONTHS.**
- **CRIMES MEASURED: RAPE, ROBBERY, ASSAULT, BURGLARY, PERSONAL AND HOUSEHOLD LARCENY, MOTOR VEHICLE THEFT, COMMERCIAL BURGLARY AND ROBBERY.**
- **SURVEY OF ATTITUDES: FEAR OF CRIME; CHANGES IN LIFESTYLE AS A RESULT OF VICTIMIZATION; OPINIONS ABOUT POLICE EFFECTIVENESS.**

VICTIMIZATION

PROGRAM RESULTS

- **ANNUAL SURVEYS CONDUCTED SINCE JULY 1972**
- **NINE PUBLICATIONS ON FINDINGS WITH THIRTY REPORTS SCHEDULED FOR PUBLICATION IN FY 77**
- **SELECTED FINDINGS INCLUDE:**
 - **NO SIGNIFICANT CHANGE OCCURRED IN RATES FOR CRIMES MEASURED BETWEEN 1974 AND 1976**
 - **AS MANY AS ONE-HALF TO TWO-THIRDS OF VICTIMIZATIONS ARE NOT REPORTED TO POLICE**
 - **COMMERCIAL CRIMES ARE USUALLY REPORTED**
 - **FEAR OF CRIME IS GREATEST AMONG PEOPLE WHO HAVE THE LEAST CHANCE OF BEING VICTIMIZED.**

RESEARCH

NATIONAL INSTITUTE OF LAW ENFORCEMENT AND CRIMINAL JUSTICE

FUNCTIONS:

- DESIGN AND SPONSOR RESEARCH
- EVALUATE CRIMINAL JUSTICE PROGRAMS
- PROMOTE ADOPTION OF PROVEN TECHNOLOGY AND SUCCESSFUL PRACTICES
- DISSEMINATE INFORMATION TO CRIMINAL JUSTICE COMMUNITY

MAJOR RESEARCH AREAS:

- JURY OPERATIONS
- SENTENCING GUIDELINES
- POLICE PERFORMANCE MEASURES
- LIGHTWEIGHT BODY ARMOR
- CRIME PREVENTION THROUGH ENVIRONMENTAL DESIGN
- CRIMINAL INVESTIGATIONS
- POLICE RESPONSE TIME

KEY RESEARCH RESULTS

JURY OPERATIONS:

- JURY POOLS CAN BE CUT 20 to 25% WHILE STILL MAINTAINING ADEQUATE TRIAL COVERAGE
- NATIONWIDE, SAVINGS COULD TOTAL \$60 MILLION ANNUALLY
- SOME COURTS ALREADY USING THE NEW METHODS, WITH NEW YORK COUNTY REPORTING \$1.2 MILLION ANNUAL SAVINGS
- JURY REFORM PROGRAMS BEGINNING IN 18 COURT SYSTEMS WITH INSTITUTE FUNDING.

POLICE RESPONSE TIME:

- CITIZENS FAIL TO REPORT MOST CRIMES IMMEDIATELY
- REPORTING DELAYS DIMINISH IMPACT OF RAPID POLICE RESPONSE TIME
- FINDINGS HAVE IMPLICATIONS FOR MANPOWER ALLOCATION, COMMUNICATIONS TECHNOLOGY, AND CRIME REPORTING PATTERNS.

CRIMINAL INVESTIGATIONS:

- VICTIM/WITNESS KEY TO SOLVING MOST CRIMES
- INFORMATION FROM CRIME SCENE MORE IMPORTANT THAT "LEADS" DEVELOPED LATER ON
- SCREENING PROCEDURES DEVELOPED TO HELP POLICE DECIDE WHETHER CASE CAN BE PRODUCTIVELY PURSUED
- IMPROVED INVESTIGATIVE PROCEDURES TO BE TESTED IN FIVE JURISDICTIONS.

KEY RESEARCH RESULTS

LIGHTWEIGHT BODY ARMOR:

- **INCONSPICUOUS, CAN BE WORN ROUTINELY**
- **FIELD TESTED IN 15 MAJOR CITIES**
- **CREDITED WITH SAVING THE LIVES OF 3 OFFICERS AND AND PREVENTING SERIOUS INJURY TO ANOTHER 10**

SENTENCING GUIDELINES:

- **DESIGNED TO REDUCE DISPARITY WITHIN A JURISDICTION**
- **GUIDELINE SENTENCES COVER 86 PERCENT OF CASES**
- **DENVER NOW USING GUIDELINE SYSTEM**
- **GUIDELINES BEING DEVELOPED IN CHICAGO, NEWARK AND PHOENIX**

POLICE PERFORMANCE MEASURES:

- **ARREST DATA AND REPORTED CRIME FIGURES INADEQUATE MEASURES**
- **NEW SYSTEM USES A VARIETY OF "INDICATORS" TO ASSESS A DEPARTMENT'S PRODUCTIVITY**
- **SOUND PERFORMANCE EVALUATION METHODS INCREASINGLY CRUCIAL IN LIGHT OF BUDGETARY PRESSURES**
- **TESTING TO BEGIN SOON IN FOUR CITIES.**

EVALUATION RESULTS

- **EVALUATE IMPACT OF NEW LAWS AND PRACTICES SUCH AS STATE SPEEDY TRIAL LEGISLATION, MASSACHUSETTS GUN LAW, NEW YORK DRUG LAW AND CLOSING OF SECURE FACILITIES FOR JUVENILE OFFENDERS**
- **EVALUATE WIDELY-USED CRIMINAL JUSTICE PRACTICES:**
 - 27 PROGRAMS EVALUATED TO DATE, RANGING FROM JUVENILE DIVERSION TO PREVENTATIVE PATROL TO STREET LIGHTING**
 - SOME FINDINGS INCLUDE:**
 - PROPERTY-MARKING PROJECTS REDUCE BURGLARY RATES FOR PARTICIPANTS, BUT COMMUNITY-WIDE RATES MAY BE UNAFFECTED**
 - ALARM SYSTEMS LINKED DIRECTLY TO POLICE EFFECTIVE IN REDUCING COMMERCIAL ROBBERIES**
 - DRUG ABUSERS IN TASC PROGRAMS SHOW LOW REARREST RATES WHILE IN PROGRAM, BUT FOLLOW-UP STUDIES NEED TO MEASURE LONG TERM PROGRESS**
- **IN TOTAL, OVER 100 POLICY RELEVANT EVALUATIONS AND ASSESSMENTS HAVE BEEN CONDUCTED TO DATE.**

ANNUAL BUDGET
\$75 M

OFFICE OF JUVENILE JUSTICE AND DELINQUENCY PREVENTION

JUVENILE JUSTICE AND DELINQUENCY PREVENTION ACT 1974 (PUB. 1. 93 - 415)

PROGRAM OPERATIONS

SPECIAL EMPHASIS:

**DISCRETIONARY GRANTS FOR IMPLEMENTING
AND TESTING DEMONSTRATION PROGRAMS**

FORMULA GRANTS AND TECHNICAL ASSISTANCE:

**PROVIDE FINANCIAL AND TECHNICAL
ASSISTANCE TO STATE AND LOCAL
AGENCIES**

CONCENTRATION OF FEDERAL EFFORT:

**DEVELOP OBJECTIVES AND PRIORITIES TO
COORDINATE ALL FEDERAL POLICIES AND
PROGRAMS RELATED TO JUVENILE
DELINQUENCY**

NATIONAL INSTITUTE (J.D. RESEARCH)

**STATISTICS AND DATA BASE:
ESTABLISH INFORMATION CLEARINGHOUSE**

TRAINING:

**PROVIDE TRAINING PROGRAMS FOR
JUVENILE JUSTICE PROFESSIONALS AND
OTHER PRACTITIONERS**

STANDARDS:

**DEVELOPMENT OF COMPREHENSIVE
STANDARDS FOR ADMINISTRATION OF
JUVENILE JUSTICE**

RESEARCH AND EVALUATION:

**ESTABLISH CENTRALIZED RESEARCH EFFORT
EVALUATION OF FEDERAL AND STATE
J.J. PROGRAMS**

OFFICE OF JUVENILE JUSTICE AND DELINQUENCY PREVENTION

PROGRAM OPERATIONS

SPECIAL EMPHASIS:

AWARDED:

- DEINSTITUTIONALIZATION OF STATUS OFFENDERS - 11 ACTION PROGRAMS
- DIVERSION - 11 ACTION PROGRAMS
- INTERAGENCY GRANT ON SCHOOL VIOLENCE TO OFFICE OF EDUCATION

FORMULA GRANTS AND TECHNICAL ASSISTANCE:

- 46 STATES HAVE COMPREHENSIVE PROGRAMS
- TWO MAJOR CONTRACTS FOR FORMULA GRANTS AND SPECIAL EMPHASIS T.A. PROGRAMS

CONCENTRATION OF FEDERAL EFFORT:

PUBLISHED FIRST ANALYSIS AND EVALUATION OF ALL FEDERAL JUVENILE DELINQUENCY RELATED PROGRAMS

NATIONAL INSTITUTE (J.D. RESEARCH)

TRAINING:

- PREPARED OFFICE TRAINING PLAN
- PROVIDED TRAINING FOR JUVENILE COURT JUDGES
- IMPLEMENTED ACA PROJECT READ IN TRAINING SCHOOLS

STANDARDS:

- 66 JUVENILE JUSTICE STANDARDS SUBMITTED TO CONGRESS
- 140 STANDARDS READY FOR SUBMISSION
- 37 PREVENTION STRATEGIES COMPLETED

RESEARCH AND EVALUATION:

- GRANTS AWARDED TO EVALUATE SPECIAL EMPHASIS PROGRAMS
- IMPLEMENTED NATIONAL ASSESSMENT PROGRAM
- GRANTS AWARDED TO IMPLEMENT A RESEARCH AND DEMONSTRATION PROGRAM ON LEARNING DISABILITIES AND JUVENILE DELINQUENCY

MAJOR MANAGEMENT IMPROVEMENTS

PURPOSE: TO PROVIDE EFFECTIVE MANAGEMENT DIRECTION AND MANAGEMENT CONTROL.

- KEY FACTORS:**
- **MANAGEMENT-BY-OBJECTIVES**
 - **ZERO-BASED BUDGETS TIED TO MBO**
 - **PROGRAM DEVELOPMENT SYSTEM**
 - **LONG RANGE PLANS FOR SYSTEMS AND STATISTICS**
 - **LONG RANGE EVALUATION PLAN AND EVALUATION UTILIZATION SYSTEM**
 - **INFORMATION SYSTEM (PROFILE) TO MEET MANAGEMENT INFORMATION NEEDS**
 - **MONTHLY MANAGEMENT REVIEWS**
 - **GRANT/CONTRACT REVIEW BOARD**
 - **GRANT-MONITORING SYSTEM**
 - **ACCOUNTING SYSTEM APPROVED BY GAO**

**LEAA Budget History
(In \$ Millions)**

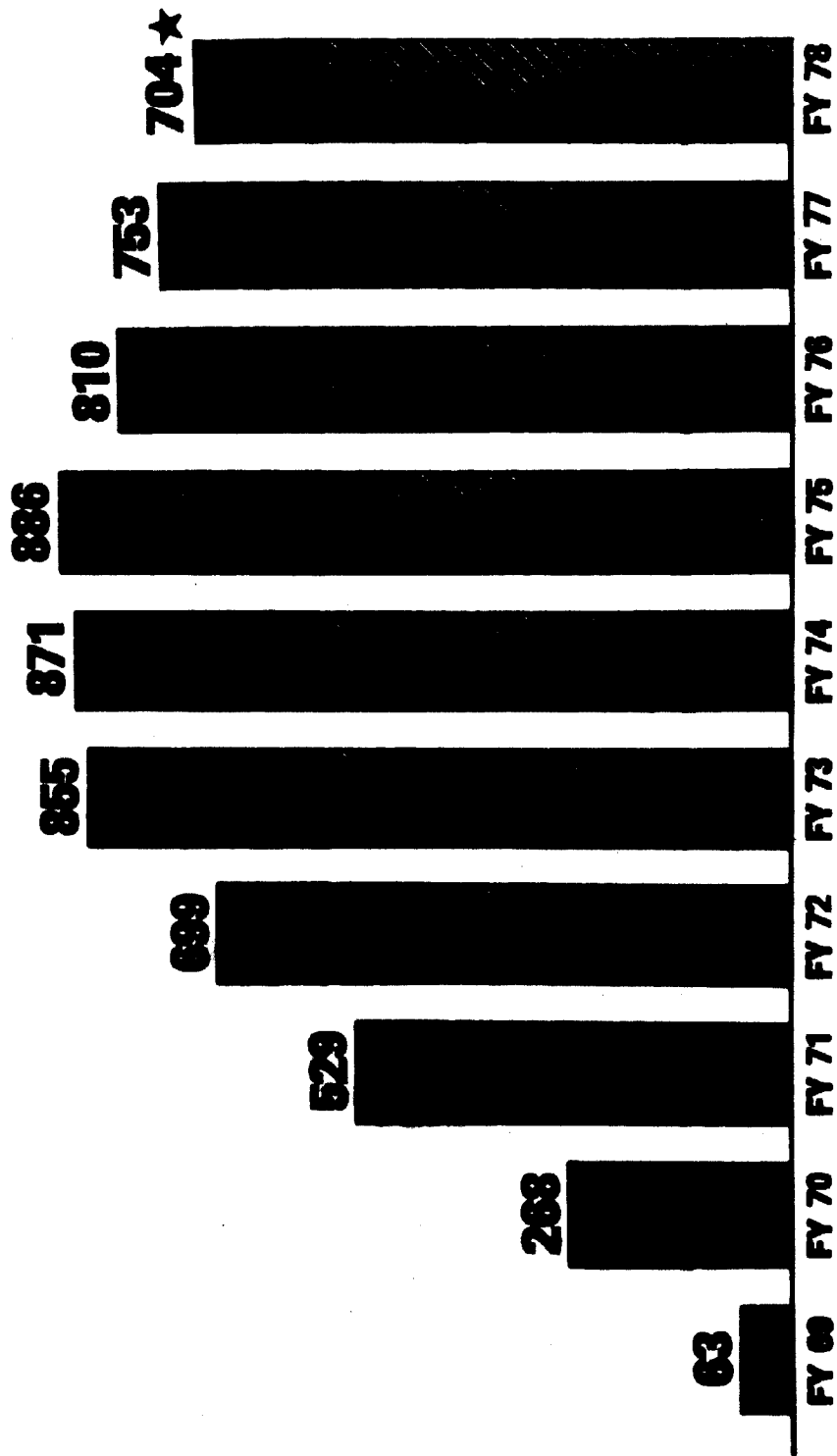

*** REQUESTED**

THE LEAA DOLLAR Fiscal Year 1977 - \$754 Million

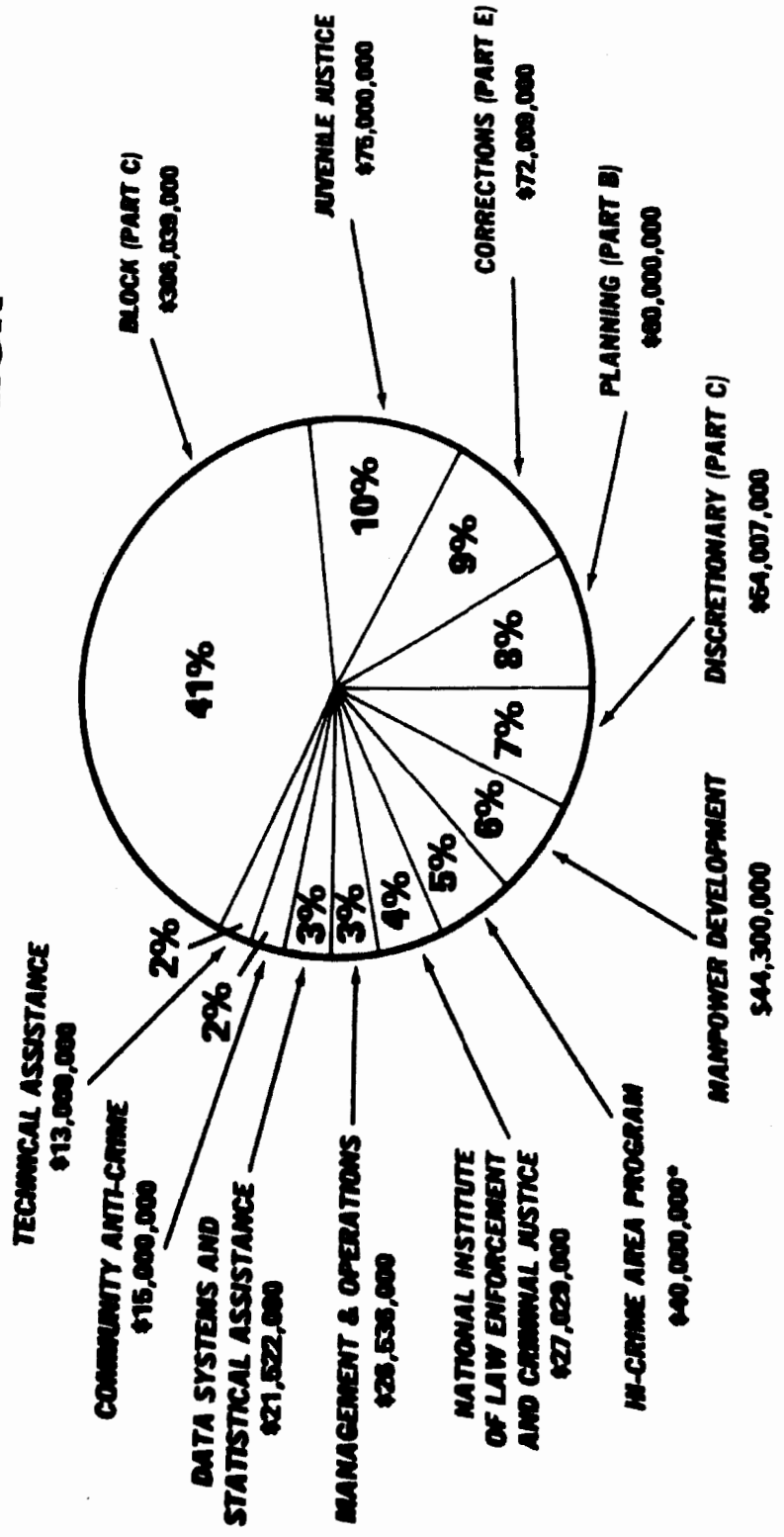

* Proposed reprogramming as follows: PSOB- \$30 M, Part C & E - \$10 M.

BUDGET BY FUNCTION — POLICE/ADJUDICATION/CORRECTIONS

FY 1976

AS % OF TOTAL CRIMINAL JUSTICE EXPENDITURE

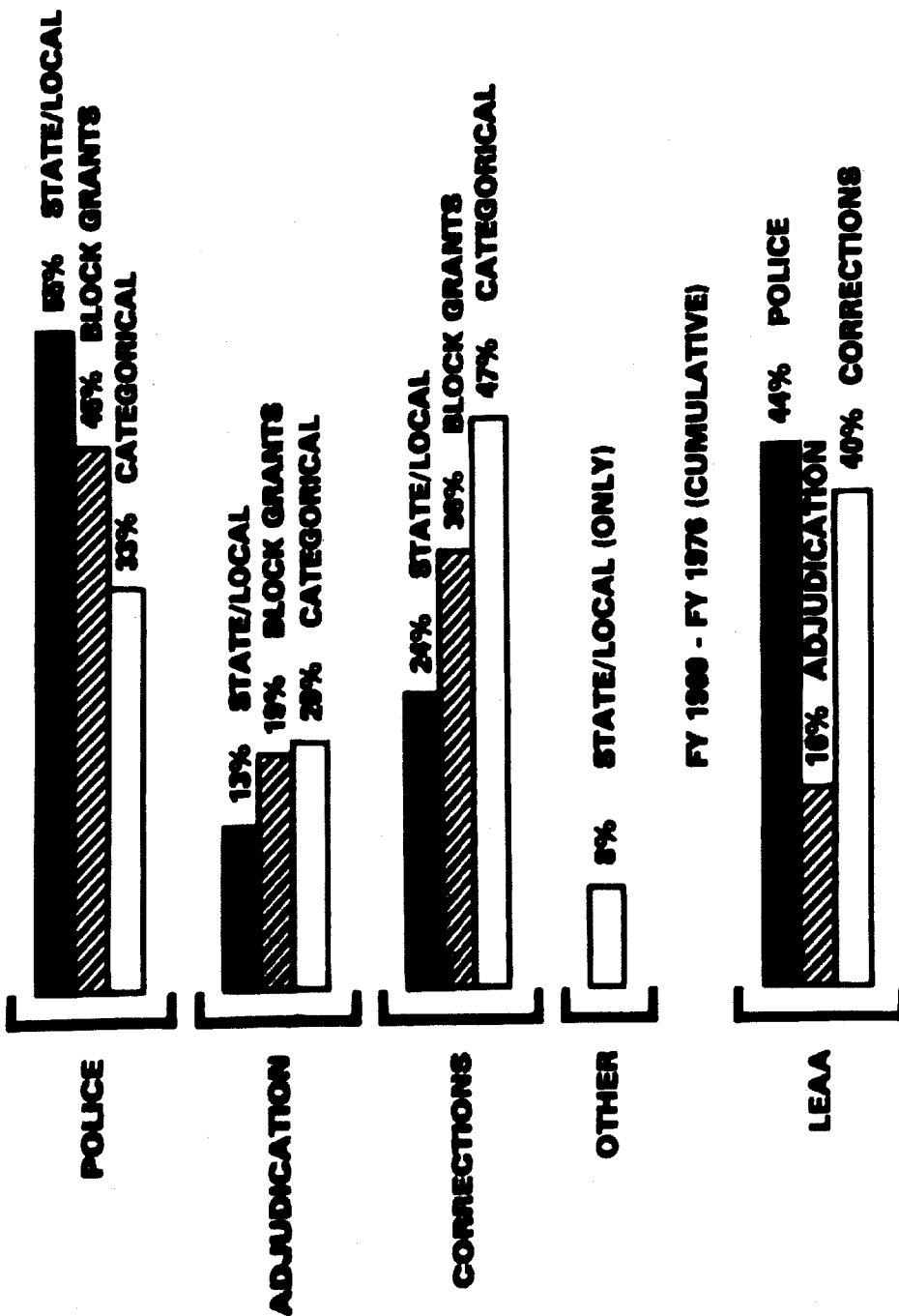

**LEAA BUDGET FUNCTION BY YEAR
(IN THOUSANDS OF DOLLARS) AS OF 12/31/76**

	POLICE			COURTS			CORRECTIONS			TOTAL	BUDGET AUTHORITY
1969 - 1974											
BLOCK	964,490	49%	306,210	16%	715,136	36%			1,984,826		
NONBLOCK	246,924	39%	87,963	14%	301,196	47%			634,173		
TOTAL	1,208,504	46%	383,163	15%	1,016,332	39%			2,618,999	3,286,310	80%
1975											
BLOCK	266,242	46%	84,911	19%	183,403	36%			463,556		
NONBLOCK	61,579	33%	37,800	29%	86,736	47%			186,415		
TOTAL	287,121	42%	122,711	19%	269,139	36%			639,971	866,000*	72%
1976											
BLOCK	167,927	39%	63,476	23%	103,967	36%			275,369		
NONBLOCK	66,572	29%	36,780	17%	122,346	54%			227,698		
TOTAL	174,499	36%	102,256	20%	226,313	46%			503,067	809,638	62%
TOTAL	1,277,649	47%	463,566	17%	962,526	36%			2,713,771		
BLOCK	373,475	36%	184,533	16%	510,278	49%			1,048,286		
TOTAL	1,651,124	44%	618,129	16%	1,492,804	40%			3,762,057	4,969,948	75%

* INCLUDES FUNDS FOR JUVENILE JUSTICE AND DELINQUENCY PREVENTION ACT.
DOJ-1977-02

**AMENDMENTS TO TITLE I (LEAA) OF THE OMNIBUS
CRIME CONTROL AND SAFE STREETS ACT**

HEARING
BEFORE THE
SUBCOMMITTEE ON
CRIMINAL LAWS AND PROCEDURES
OF THE
COMMITTEE ON THE JUDICIARY
UNITED STATES SENATE
NINETY-FOURTH CONGRESS

SECOND SESSION

ON

**S. 460, S. 1297, S. 1598, S. 1601, S. 1875,
S. 2212, S. 2245 and S. 3043**

OCTOBER 2, 8, 9, 22, 23, NOVEMBER 4, DECEMBER 4, 1975 AND
MARCH 17, 1976

Printed for the use of the Committee on the Judiciary



U.S. GOVERNMENT PRINTING OFFICE

69-103 O

WASHINGTON : 1976

ADD80

But Congress also hears another voice from the public, and most of them say cut our taxes, cut our expenditures, let us get sensible about this thing so that we will have a little to live on and save a little for our children to go to school and retirement and so on. So Congress is listening, but they are listening to different parts, perhaps, of the people's cry.

Mr. REED. We are well familiar with this, Mr. Chairman.

I think you will agree with me that the criminal justice system and especially the prisons and jails, constitute a stronghold for our society. Now, there are those who would breach that stronghold. There are those who for their own reasons would eliminate prisons, would denigrate the activities that go on in jails and prisons. I propose to you, Mr. Chairman, that if this stronghold is breached, we will no longer have a society. And whatever the cost is, within reason, we must some way or other provide the reasonable resources for sustaining that stronghold in conformity with our constitutional and our good American expectations.

Senator HRUSKA. Well, it is associations like your which could do much to stir public thought and also, hopefully, some action along these lines that you have described so well.

Mr. REED. We are trying, sir.

Senator HRUSKA. So give the greetings of the subcommittee to your associates in that association. Tell them to be of good cheer. We are going to do the best we can.

Mr. REED. Thank you, sir.

Senator HRUSKA. And thanks for your help.

Our final witness for the day is Richard W. Velde who is Administrator of the Law Enforcement Assistance Administration.

Mr. Velde, some time ago you appeared here and gave us the opening scenario of these hearings. Since then we have had many witnesses and many points of view expressed in this forum. I know you have followed those hearings and the testimony very carefully and methodically, and the size and the scope of your 26-page statement indicates as much.

I know it would be helpful—the statement is long, and yet, in having read it last night and early this morning I suggest it would be a good reference work to those who have any specific ideas or criticisms to voice; because for every action there is a reaction, and we know that. We had some in the last 2 minutes.

We have had a subject that is dear to your heart—namely, the idea that there are so many guidelines that they are oppressive and frustrating and burdensome, and they never cease to come. I know you will in due time address yourself to that.

We welcome you here once again, and we will print in the record this statement that you have submitted in its entirety.

You may now proceed in your own fashion, to highlight it or skip-read it, as you choose.

[The material referred to follows:]

ADDITIONAL STATEMENT OF RICHARD W. VELDE, ADMINISTRATOR, LAW ENFORCEMENT ASSISTANCE ADMINISTRATION, CONCERNING LEGISLATION WHICH WOULD AMEND THE OMNIBUS CRIME CONTROL AND SAFE STREETS ACT OF 1968

Mr. Chairman, I appreciate your invitation to again appear before the Subcommittee on Criminal Laws and Procedures in my capacity as Adminis-

Section 301(d) provides that not more than one-third of any Part C grant awarded to a state may be expended for compensation of police and other regular law enforcement and criminal justice personnel. The one-third salary provision was included in the Safe Streets Act because the Congress was concerned that responsibility for law enforcement not be shifted from state and local governments to the Federal Government. In addition, federal funds might supplant state and local efforts, instead of supplementing them.

In a few instances, remarks have been directed to the Subcommittee to the effect that there is excessive "red tape" involved in the administration of the LEAA grant program. While in some cases, regrettable and unforeseen difficulties have arisen and caused delay to certain applicants, I believe the Subcommittee will find that overall the program has been administered effectively and efficiently.

Prior testimony before the Subcommittee made reference to 1,200 pages of guidelines issued by LEAA to implement a 23 page Act. Such statements can be very misleading. LEAA has implemented the statute in a manner consistent with the intent of Congress in establishing the block grant program. Much of the material contained in guideline manuals is informational. Included are such items as reprints of the statute, OMB circulars, standard application forms, reporting forms, fund allocation tables, and address lists. All this material is provided for the convenience of the user, not to impose additional burdens on applicants, as one might be led to believe.

An example of the manuals issued by LEAA is the most recent edition of the "Guide for Discretionary Grant Programs." This manual, which is LEAA's largest program guideline document, has 224 pages of requirements and specifications. However, the specifications are for numerous different categories of programs. Any particular applicant would need only refer to the two or three pages under which funds were being sought, and a few pages of general requirements. In addition to the guideline requirements, the manual contains 15 informational appendices.

It should be noted that some of the information provided in LEAA guideline manuals relate not to requirements arising out of LEAA's legislation, but to other federal statutes which have been passed to deal with crucial issues of national concern. Examples of such statutes which may be considered by some critics to be LEAA "red tape," but over which we have no control, are the National Environmental Policy Act, the Clean Air Act, the Federal Water Pollution Control Act, the National Historic Preservation Act, the Uniform Relocation Assistance and Real Property Acquisition Act, and the Safe Drinking Water Act. Thus, it is unfair to single out LEAA as the cause for many requirements being imposed on those seeking assistance.

As you know, Mr. Chairman, provisions have been added to LEAA's enabling legislation which help assure swift action. By law, LEAA must approve or disapprove state comprehensive plans within ninety days of submission. State planning agencies must act on subgrant applications within ninety days of their receipt. LEAA has adopted a similar ninety day rule for consideration of any discretionary grant applications. I might add, Mr. Chairman, that there have been well over 100,000 grants made during the course of the LEAA program, with the number of applicants far exceeding that figure.

With regard to the application forms themselves, LEAA uses the standard forms for federal grant programs, prescribed by the Office of Management and Budget, in its discretionary grant program. This assures uniformity for all such applicants.

To clarify provisions of LEAA's enabling legislation and provide guidance on application, award, and grant administration procedures, a number of guideline manuals have been issued. Program manuals give information on programs and projects for which funds are available and guidance to prospective grantees about the steps to be taken in making application for funds. The manuals also give guidance to grantees on their responsibilities of applicable federal laws and regulations. Additionally specified are monitoring and evaluation policies and procedures.

Guideline manuals have also been issued to provide direction regarding specific issues concerning which grantees often require assistance. Examples are our audit guide, financial guide, and equal opportunity guidelines. Without the detailed information provided in these manuals by LEAA, many problems could arise for grantees which could only otherwise be resolved on a case-by-case basis, a very time consuming proposition.

405

Finally in this regard, Mr. Chairman, it should be pointed out that the LEAA program is essentially one administered by the states and by local governments. These jurisdictions all may have requirements which affect the management of the program, perhaps causing delay to applicants for funds. If inefficient management techniques are the cause of problems, LEAA may be able to provide the technical assistance necessary to upgrade capabilities and initiate effective techniques. In fact, we have taken such action in several instances. However, it would be inappropriate for LEAA to otherwise dictate to these jurisdictions the nature of their administrative procedures.

Representatives of state court systems appearing before the Subcommittee have taken issue with LEAA's estimate of the percentage of funds which goes for court programs. You will recall, Mr. Chairman, that we have indicated that courts projects receive in the neighborhood of 16 percent of LEAA program funds. Others, however, have voiced the opinion that the actual courts funding level is 6 or 7 percent, and have been critical of the fact that LEAA includes in the total such items as defense and prosecution projects.

It is extremely difficult to credit LEAA funds to exclusive program categories such as police, courts, or corrections. This is particularly true since as much as 40 percent of LEAA grants benefit multiple components of the criminal justice system. Criminal justice training academies receiving LEAA support are one example of this multi-component thrust. One week, courses may be given to prosecutors, one week to police officers, one week to probationary officers, and another week to judicial representatives.

Another example is the funding provided to support criminal history information systems. Such systems are used by nearly all elements of the criminal justice system, including police, the courts, and correctional agencies. There is no accurate way to assign a specific amount of these dollars to particular program categories.

Another difficulty in this regard is one of definition. There is a bona fide difference of opinion as to what actually is a court program. Certain projects to assist prosecution, defense, and probation functions have been characterized by LEAA as courts projects. Advocates of increased funding for the courts feel, however, that only those projects which directly benefit court operations be included in the definition, with other efforts being listed separately, perhaps as a new category.

LEAA is now attempting to resolve these differences and provide a discrete apportionment of all funding for courts projects under definitions acceptable to all interested parties. A special task force of judicial leaders and technicians has been commissioned to develop acceptable working definitions for categorizing projects, apply these definitions to LEAA project expenditure data, and determine the percentage of LEAA funds devoted to courts projects.

The last issues I would like to address are criticisms of the LEAA program which trouble me deeply. I am troubled not only because the criticisms are felt to be inappropriate and unwarranted, but because of the manner in which they were presented to the Subcommittee. Certain of the comments supporting the criticisms were misleading and incomplete, while other statements would clearly be shown not supported by the facts if careful investigation were undertaken. It is my hope that the Subcommittee, for the reasons I will discuss, will not be misled in its deliberations with respect to the LEAA program as a result of this testimony.

One issue which was raised in the testimony concerned certain aspects of LEAA's civil rights compliance effort. Because the organization which the witness represents is, and was at the time of the prior testimony, engaged in litigation with LEAA on these very matters, it would be highly inappropriate for me to discuss the substance of those particular remarks in this forum. LEAA is now preparing its response to the allegations involved in the litigation and will be most happy to provide the Subcommittee with a copy when formally submitted to the court. Needless to say, LEAA believes it is very effectively enforcing its civil rights responsibility, and it is felt that the results of litigation will clearly establish this fact.

LEAA's role in the development of information systems and the impact of such systems upon individual privacy was also called into question by this same witness. For the full information of the Subcommittee, I would like to briefly describe LEAA's involvement in the area of criminal justice information systems.

ADD83

**RESTRUCTURING THE LAW ENFORCEMENT
ASSISTANCE ADMINISTRATION**

HEARINGS
BEFORE THE
SUBCOMMITTEE ON CRIME
OF THE
COMMITTEE ON THE JUDICIARY
HOUSE OF REPRESENTATIVES
NINETY-FIFTH CONGRESS
FIRST AND SECOND SESSIONS
PART 1

AUGUST 1; OCTOBER 3, 4, 20, 1977; AND MARCH 1, 1978

Serial No. 95-38



Printed for the use of the Committee on the Judiciary

U.S. GOVERNMENT PRINTING OFFICE
WASHINGTON : 1978

30-813

H521-29

ADD84

Mr. CONYERS. Having said that, we now recognize and welcome Associate Deputy Attorney General Walter M. Fiederowicz; Assistant Attorney General, Ms. Patricia M. Wald; General Counsel for LEAA, Thomas Madden; the Acting Director of the National Institute of Law Enforcement, Blair Ewing; Mr. James Gregg, Acting Administrator of LEAA, and Paul Nejelski, also a member of the task force study group.

We welcome you all, ladies and gentlemen. We know that the Deputy Attorney General has sent a prepared statement, and we would welcome you to proceed with it in your own way.

TESTIMONY OF WALTER M. FIEDEROWICZ, ASSOCIATE DEPUTY ATTORNEY GENERAL, ACCOMPANIED BY PATRICIA M. WALD, ASSISTANT ATTORNEY GENERAL FOR THE OFFICE OF LEGISLATIVE AFFAIRS; BLAIR G. EWING, ACTING DIRECTOR OF THE NATIONAL INSTITUTE OF LAW ENFORCEMENT; PAUL A. NEJELSKI, OFFICE OF IMPROVEMENTS IN THE ADMINISTRATION OF JUSTICE; THOMAS J. MADDEN, GENERAL COUNSEL, LAW ENFORCEMENT ASSISTANCE ADMINISTRATION; AND JAMES M. H. GREGG, ACTING DIRECTOR OF THE LAW ENFORCEMENT ASSISTANCE ADMINISTRATION

Mr. FIEDEROWICZ. Although the Deputy Attorney General cannot be here today, I would like his statement introduced in the record.

I also have a prepared statement, fairly lengthy, of which I would like to read excerpts and have the full statement introduced in the record, with your permission.

Mr. CONYERS. All of the prepared statements will be incorporated into the record.

[The prepared statements of Messrs. Fiederowicz and Flaherty follow:]

STATEMENT OF PETER F. FLAHERTY, DEPUTY ATTORNEY GENERAL, DEPARTMENT OF JUSTICE

The hearings which your Committee has scheduled to discuss the Department of Justice Study Group "Report to the Attorney General" come at a most opportune time because the Department is currently evaluating the recommendations contained in the Report for restructuring the Law Enforcement Assistance Administration.

Attorney General Bell and I have assigned a high priority to the improvement of the effectiveness and responsiveness of the Department of Justice's program of assistance to state and local governments for crime control and criminal justice system improvement. Among our initiatives in this area was the creation of the Study Group and our charge to the Group that it present for our consideration recommendations for change in the program.

On June 23, 1977, the Study Group submitted its Report to Attorney General Bell and me. On June 30, 1977, the Attorney General publicly released the Report and asked for specific comments on the Report for a period of sixty days beginning on July 1, 1977.

In response to the Attorney General's request for public comment, the Attorney General and I have received a number of letters and reports which cogently discuss the LEAA program and its future. I find this response heartening. As the Attorney General noted in releasing the report: "Crime is a problem which

touches every one of us. A Federal role in this area must be shaped with the greatest possible participation of the American people and their elected leaders."

At this time and until the end of the sixty-day comment period, the Attorney General and I will be studying the "Report to the Attorney General," as well as the various documents that we receive in response to the Attorney General's request for commentary upon the Report.

I know that the hearings which your Committee has scheduled will enhance the quality of the discussion of the issues raised in the Study Group's "Report to the Attorney General" and will assist Attorney General Bell and me to evaluate the Report and the issues which it addresses.

The Attorney General and I look forward to working closely with you to resolve those issues.

STATEMENT OF WALTER M. FIEDEROWICZ, OFFICE OF THE ATTORNEY GENERAL,
DEPARTMENT OF JUSTICE

Mr. Chairman, I want to take this opportunity on behalf of the Department of Justice and the members of the Study Group to thank you for this opportunity to appear before your Committee to discuss its "Report to the Attorney General" regarding the restructuring of the Law Enforcement Assistance Administration.

The Attorney General has made the improvement of the Law Enforcement Assistance Administration and its programs one of his top priorities. In April of this year, he organized the Study Group and asked it to conduct a comprehensive review of the present LEAA program and to undertake a basic rethinking of the Department of Justice's program of assistance to state and local governments in crime control and criminal justice system improvement. On June 23, 1977, the Study Group submitted its Report to the Attorney General and the Deputy Attorney General. On June 30th, because of his belief that a "Federal role in this area must be shaped with the greatest possible participation of the American people and their elected leaders," Attorney General Bell publicly distributed the Report and solicited comments concerning the Report.

During the comment period, which extends through the end of August, the Attorney General and the Deputy Attorney General will be considering the Study Group's recommendations and the comments they receive from public officials and the general public. Only after such a process has been completed will the Attorney General and the Deputy Attorney General adopt a position concerning the recommendations contained in the "Report to the Attorney General". Accordingly, I would like to emphasize that the conclusions and recommendations of the Study Group in its "Report to the Attorney General" do not necessarily reflect the official views of the Department of Justice on the issues addressed in the Report. Similarly, I would like to emphasize that at these hearings my colleagues and I can speak only on behalf of the Study Group and not on behalf of the Department of Justice.

Today, I would like to briefly outline the process followed by the Study Group in examining the LEAA program and to highlight the key findings contained in the Report. In the session scheduled for Thursday it is my understanding that we will be asked to discuss the specific recommendations contained in the Report.

Serving with me on the Study Group were six individuals who have had a wide range of experience in and out of government. Patricia M. Wald, Assistant Attorney General for the Office of Legislative Affairs, has among numerous other activities, served as a member of the President's Commission on Crime in the District of Columbia, as a consultant to the President's Commission on Law Enforcement and Administration of Criminal Justice and on the Executive Committee of the Juvenile Justice Standards Project IJA-ABA.

Ronald J. Galner currently serves as Deputy Assistant Attorney General for the Office for Improvements in the Administration of Justice. Prior thereto, Mr. Galner served as an attorney in the Criminal Division of the Department of Justice and as Director of the Department's Office of Policy and Planning. In these positions, Mr. Galner has had an opportunity to work on a number of criminal justice matters on a policy-making level and to review the operations of the LEAA program for the Department of Justice.

Paul A. Nejelski, Deputy Assistant Attorney General for the Office for Improvements in the Administration of Justice, was employed by LEAA in its National Institute of Law Enforcement and Criminal Justice in 1969 and 1970. He

"In summary, then, the lessons of the past nine years of the LEAA program have been mixed. The comprehensive review undertaken by the Study Group led to the conclusion that there is the need for a major restructuring of the Justice Department's program of assistance to state and local governments for crime control and criminal justice improvements. This major restructuring must take place in the context of both the positive as well as the negative lessons of the past. LEAA was always viewed as an experiment. It is time now to capitalize on the lessons of nine years of experience and design a better Federal response to the nation's crime problem."

Based upon its review of the LEAA program and its findings, the Study Group identified certain major issues pertinent to the future of LEAA, and made recommendations to the Attorney General concerning those issues. Mr. Nejeleski concurred only with recommendations Nos. 1 and 2 of the Report.

As I mentioned at the outset, the Attorney General and the Deputy Attorney General are reviewing the Report. Over 3,000 copies of the Report have been distributed for public comment. A listing of the individuals and groups who have received copies of the Report is attached to my testimony. The Study Group will be reviewing and analyzing responses to the Report, as will the staff of the Attorney General and the Deputy Attorney General. Your hearings come at a most opportune time to assist the Department of Justice in its evaluation of LEAA and its future.

My colleagues and I would be pleased to attempt to respond to any questions the Committee may have.

DISTRIBUTION OF THE REPORT TO THE ATTORNEY GENERAL

As of this date, over 3,000 copies of the report have been distributed among the following groups:

- (a) All members of the U.S. Congress.
- (b) All Governors.
- (c) All State Attorneys General.
- (d) All State Chiefs Justice.
- (e) The Mayors of the 120 Largest Cities.
- (f) All State Planning Agencies under the LEAA Program.
- (g) All major national interest groups including:
 - (1) National Governors Conference;
 - (2) National Association of Criminal Justice Planning Directors;
 - (3) National Association of Regional Councils;
 - (4) National Association of Counties;
 - (5) National Conference of State Criminal Justice Planning Administrators;
 - (6) National Conference of State Legislators;
 - (7) National League of Cities/U.S. Conference of Mayors;
 - (8) Advisory Commission on Intergovernmental Relations;
 - (9) International City Management Association;
 - (10) National Center for State Courts;
 - (11) American Correctional Association;
 - (12) Council of State Governments;
 - (13) American Bar Association;
 - (14) National Sheriffs Association;
 - (15) International Association of Chiefs of Police;
 - (16) National Legal Aid and Defender Association;
 - (17) National Association of Attorneys General;
 - (18) National District Attorneys Association;
 - (19) National Urban League;
 - (20) National Association of Neighborhoods;
 - (21) National Peoples Action;
 - (22) National Center for Community Action;
 - (23) National Council of La Raza; and
 - (24) National Congress for Community Economic Development.
- (h) All Major Newspapers.
- (i) The General Public upon request.

Mr. FIEDEROWICZ. Thank you.

**FEDERAL ASSISTANCE TO STATE AND
LOCAL CRIMINAL JUSTICE AGENCIES**

HEARING
BEFORE THE
SUBCOMMITTEE ON
CRIMINAL LAWS AND PROCEDURES
OF THE
COMMITTEE ON THE JUDICIARY
UNITED STATES SENATE
NINETY-FIFTH CONGRESS
SECOND SESSION
ON
S. 1245, S. 1882, S. 3270, and S. 3280

PART I
**RESTRUCTURING THE LAW ENFORCEMENT
ASSISTANCE ADMINISTRATION**

AUGUST 16 AND 23, 1978

Printed for the use of the Committee on the Judiciary



U.S. GOVERNMENT PRINTING OFFICE
WASHINGTON : 1978

35-662

5521-17

ADD88

the State role should be strengthened. We will hear from the cities about how the city role should be strengthened. We have tried to develop an imaginative concept of arbitration. We have provided new flexibility so that if the cities do not get sufficient resources, they can get more under other formulas.

This legislation has flexibility. I think it makes clear that if we had a \$6 billion authorization for this year, we might do a lot more. But we do not have that.

One of the principles of this administration has been trying to target limited resources through leveraging. We are not going to be able to do everything, but we can make this a responsible program. We can make the Federal Government's limited participation with local communities, States, and counties an important instrument to help meet one of the great concerns of the citizens of this Nation.

So I look forward to working with the chairman of this subcommittee and the other members. I regret I will not be able to hear the testimony, but I have reviewed the testimony, Attorney General Bell and Governor Hunt. I was prepared to develop some of these points with you. I think the testimony will be excellent and I will try to get back.

I give you the assurance that I have read your testimony in detail prior to the hearing. I will look forward to working with you.

Thank you, Mr. Chairman.

Senator BIDEN. Without objection, Senator Kennedy, your statement shall become a part of this hearing record at this point.

[Material follows:]

STATEMENT OF SENATOR EDWARD M. KENNEDY AT OPEN HEARINGS ON THE REAUTHORIZATION OF THE LAW ENFORCEMENT ASSISTANCE ADMINISTRATION

Today, the Subcommittee on Criminal Laws and Procedures begins a comprehensive series of hearings on the future of the Federal Law Enforcement Assistance Administration. These hearings are aimed at analyzing the structure, method, goals and future of the current LEAA program, which is subject to reauthorization next year. In a broader sense, these hearings provide us with an opportunity to examine the federal government's role in aiding local crime-fighting efforts.

The development of just, workable proposals for combating crime is an urgent concern of all of us. It is an intolerable situation in this Nation when our own citizens cannot walk down the streets without facing the dangers of robbery, mugging and other street crimes. Although there are no hidden panaceas for eliminating crime from our society, it is clear that certain measures can and must be taken to make our streets safe and our citizens secure. I am convinced that the federal government does have a limited, but very important role to play in this area. LEAA is both the symbol and the reality of the federal government's modest commitment to assist localities in this continuing struggle. We need LEAA.

The major legislative vehicle for reorganizing and restructuring the LEAA program is S. 3270, the "Justice System Improvement Act of 1978," which I introduced, with strong administration and bipartisan support last month. This bill is designed to make the LEAA program more efficient and effective. It has been personally endorsed by both President Carter and Attorney General Bell and should go a long way in eliminating the defects and faults which have plagued the LEAA program during the past decade.

These current defects are many: poor priorities; excessive redtape; lack of clearly delineated federal, state, and local crime-fighting roles; excessive state control of the program at the expense of the cities and counties; poor internal LEAA structural organization; absence of effective research and evaluation components; lack of clearly understandable purposes and goals; poor targeting of block grant funds and the failure of comprehensive planning.

But beyond these specific defects, there remain troublesome general questions concerning LEAA—why does LEAA remain the stepchild of the federal grant programs? Did LEAA get off on the wrong foot in 1968 with its extensive hardware and antiriot purchases? Is the program still perceived in ideological terms, as "law and order" oriented?

During the past year I have been engaged in lengthy discussions with the Department of Justice in an effort to make the program more effective. These discussions have been most cooperative and constructive. But the basic roots of S. 3270 go all the way back to the early 1970's, when I first proposed steps to improve the functioning of the program. For too long the Congress has been unable or unwilling to confront the structural and administrative defects which hinder LEAA. In 1970, 1973, and, especially in 1976, various amendments were made to the program in an effort to improve it; but these amendments, although important and constructive, were largely band-aid reforms, aimed at particular LEAA weaknesses. Major surgery was left for another day.

I continue to question, not the concept of federal assistance to aid localities in the war on crime, but, rather, the nature and administration of that assistance. Since 1968 LEAA has authorized expenditures totaling over \$6 billion, and yet many, including myself, question how this money has been spent. I am, of course, aware that crime is primarily a local problem and that LEAA's role is, by necessity, limited. But the issue is not whether LEAA can cure the nation's crime problem—it cannot—but whether LEAA can be altered and restructured in order to make a more meaningful contribution. I believe it can.

S. 3270 attempts to provide the type of comprehensive reform which has not taken place during the last decade. I believe this bill and these hearings will go a long way in making LEAA the type of federal agency contemplated by Congress when it enacted the LEAA program in 1968.

The Justice System Improvement Act is not a palliative; it constitutes a major break with the existing program. All of the major concepts found in the current statute—block grant assistance, discretionary funding, the National Institute of Justice, criminal justice planning—are substantially restructured and reorganized to meet the constructive criticisms raised during recent years. Thus, the bill: (1) creates a separate National Institute of Justice and Bureau of Justice Statistics within the Justice Department—and outside of LEAA—and places both of them, in addition to LEAA under a new umbrella office—the Office of Justice Assistance, Research and Statistics; (2) eliminates the annual comprehensive plan requirement and its attendant red tape; (3) replaces state planning agencies; (4) prohibits the expenditure of LEAA funds for equipment and hardware unless such expenditures are a necessary part of a larger innovative program; (5) gives special emphasis to judicial needs and programs; (6) provides direct financial assistance to larger cities and counties; (7) provides greater community and neighborhood involvement in choosing local priorities and (8) creates new criminal justice formulas to target funds to local areas of greatest need.

I look forward to the upcoming testimony on S. 3270 and other LEAA bills, as we attempt to fashion a final legislative product which will give LEAA an opportunity—long overdue—to make a more meaningful contribution to the local war on crime. The provisions of these bills are not etched in stone; I believe we can do an even better job. The hearings, beginning today and continuing into next year, will give us an extended opportunity to examine the strengths and weaknesses of the pending legislation. What is needed during the months ahead is the valuable input of those manning the front lines in the battle against crime—the police, judges, corrections officers, district attorneys and the defense bar. These hearings will also afford an opportunity for us to hear from the governors, mayors, county officials, criminal justice planners and all those who have a very real, dedicated interest in seeing the LEAA program work. The hearings are designed to assure that the American taxpayer will receive a better return on his or her investment in the war on crime than on the \$6 billion spent so far. We owe it to the public to put this agency in order and to restore the confidence of the people that we are making progress in dealing with the problem of crime in America.

Senator BIDEN. Senator Thurmond?

Senator THURMOND. Mr. Chairman, today the Criminal Laws Subcommittee begins its oversight and reauthorization process for the

383

OFFICE OF THE ATTORNEY GENERAL,
Washington, D.C., July 10, 1978.

HON. WALTER F. MONDALE,
Vice President of the United States,
The White House,
Washington, D.C.

DEAR MR. VICE PRESIDENT: Enclosed for your consideration is a legislative proposal entitled the "Justice System Improvement Act of 1978" which amends in its entirety Title I of the Omnibus Crime Control and Safe Streets Act of 1968. This proposal restructures the Federal Law Enforcement Assistance Administration and is intended to assist state and local governments in improving the quality of their justice systems.

The Justice System Improvement Act provides a four-year authorization for justice assistance, research and statistics programs. The Act is significantly different than the current LEAA statute and makes major structural and substantive changes in the financial assistance, research and statistical programs now being administered by LEAA.

The Act is designed to correct the major criticisms directed at the LEAA program by simplifying the grant process and eliminating needless red tape, by the targeting of funds, by strengthening the role of local governments in the program, by eliminating wasteful use of LEAA funds, by increasing community participation in the LEAA program, and by improving justice research, demonstration, and statistics programs.

More specifically, the bill can be described as follows:

(1) STATE AND LOCAL FINANCIAL ASSISTANCE

The bill replaces the current LEAA block and discretionary grant programs with a formula grant program, a priority grant program, and a discretionary grant program. Seventy percent of such funds must be set aside for formula grants, twenty percent for priority grants and ten percent for discretionary grants. These grants are to be administered by LEAA and LEAA is to be under the direct authority of the Attorney General. Under the bill, the Administrator of LEAA has final sign-off authority on all grants and contracts and reports to the head of an Office of Justice Assistance, Research and Statistics established by the bill.

FORMULA GRANTS

The bill contemplates the submission to LEAA of a very simple three-year application which would not contain much of the verbiage that has led to larger paper submission requirements under current law. The application must be based on an analysis of the crime problems in the state and must include priorities for addressing these crime problems.

Under the new bill, the state is authorized to prepare those parts of the application which relate to state agencies and to cities under 100,000 population and counties under 250,000 population. The state courts through Judicial Coordinating Committees are authorized to prepare a single application for state court activities. Each major city and county is authorized to prepare a single application for their own activities. The State would then integrate these applications into a single application to be submitted to LEAA.

The state review of the application from major cities and counties under the bill is limited. Applications can only be reviewed for compliance with Federal requirements and state law, for duplication of other projects, and for inconsistencies with priorities. Any disagreements between state and large units of local government must be resolved through arbitration.

Formula grant funds are to be distributed on the basis of a national formula with a hold harmless provision which assures that no state receives less than a population share of the funds as under current law. The bill also contains provisions under which some states with particularly severe crime problems receive additional funds based on a formula that takes into account crime, population, tax effort, and criminal justice expenditures.

Major cities and counties receive a fixed allotment of funds from the state share. The amount of funds received is determined by a formula based on criminal justice expenditures.

ADD91

384

An annual performance report must be submitted to LEAA each year by each state. LEAA must review this performance report and, if based on this performance report or on LEAA's independent evaluation it is determined that the funds were not being used effectively, LEAA must either suspend all funds going to a jurisdiction or suspend only those funds which would be otherwise used for an ineffective program or project.

The annual state comprehensive plans now being submitted to LEAA average about 1,000 pages. The single three-year application should not exceed 300-400 pages. Over a three-year period total paper submission, including amendments and annual performance reports, could be cut by 75 percent.

NATIONAL PRIORITY GRANTS

Under the priority grants provisions of the bill, the Office of Justice Assistance, Research and Statistics is directed, after consultation with the National Institute of Justice, the Bureau of Justice Statistics, state and local governments, and others to establish programs for priority grant funding which have been shown through research, demonstration or evaluation, to be particularly effective in improving the criminal justice system and reducing crime.

In order to receive a priority grant, a state or local government must provide for 50 percent of the cost of the program or project. In providing such a matching share, a recipient can use the formula grant, general revenue sharing funds, state and local appropriations, or any other source of funds available for that jurisdiction.

DISCRETIONARY GRANTS

The bill also authorizes LEAA to award discretionary grants. Under the bill, these grants are to be used to fund programs for improving the criminal justice system which might not be otherwise undertaken under the formula or priority grant programs.

(2) NATIONAL INSTITUTE OF JUSTICE

The bill creates a National Institute of Justice within the Justice Department that replaces two existing units (the National Institute for Law Enforcement and Criminal Justice and the National Institute of Corrections) and part of a third unit (Institute of Juvenile Justice Development and Research). The bill authorizes the National Institute of Justice to undertake basic and applied research in the areas of civil and criminal justice and to conduct evaluations and sponsor demonstrations in these areas. To insure the independence and integrity of the research operation, the bill gives the Director of the National Institute of Justice sign-off authority for all grants and contracts to be awarded by the National Institute of Justice. To insure administrative responsibility, the Director of the National Institute of Justice reports to the Director of the Office of Justice Assistance, Research and Statistics. The bill establishes a National Institute of Justice advisory board to be appointed by the Attorney General and to consist of a broadly based group of the academic and research community, justice practitioners, state and local officials, officials of neighborhood and community organizations, and citizens. The board would have authority to develop, in conjunction with the Director, policies and priorities for the National Institute of Justice.

(3) BUREAU OF JUSTICE STATISTICS

The bill also creates a Bureau of Justice Statistics within the Department of Justice under the direct authority of the Attorney General. Under the bill, the Director of the Bureau of Justice Statistics reports to the Director of the Office of Justice Assistance, Research and Statistics and has final sign-off authority for all grants and contracts to be awarded by the Bureau of Justice Statistics. The Bureau of Justice Statistics is authorized to collect, analyze and disseminate statistics on criminal and civil justice matters.

The bill establishes a Bureau of Justice Statistics advisory board to be appointed by the Attorney General and to consist of a broadly based group of researchers, statisticians, justice practitioners, state and local officials and citizens. The board would have authority to recommend to the Director policies and priorities for the Bureau of Justice Statistics.

Prompt and favorable consideration of the proposed "Justice System Improvement Act of 1978" is recommended. In addition to the bill, there is enclosed a

ADD92

385

section-by-section analysis. The Office of Management and Budget has advised that there is no objection to the submission of this legislative proposal to the Congress and that its enactment would be in accord with the program of the President.

Yours sincerely,

Griffin B. Bell, Attorney General.

Enclosure.

SECTION-BY-SECTION ANALYSIS

Section 2—Title I of the Omnibus Crime Control and Safe Streets Act of 1968, as amended, is amended in its entirety as follows:

The Declaration and Purpose Clause sets out justice system improvement as the overall purpose of the new title. The clause provides that the policy of Congress is (1) to provide financial and technical assistance with maximum certainty and minimum delay; (2) to support community anti-crime efforts; (3) to encourage development of basic and applied research in the civil, criminal, and juvenile justice systems; and (4) encourage the collection and analysis of statistical information concerning crime and the operation of justice systems.

PART A—LAW ENFORCEMENT ASSISTANCE ADMINISTRATION

Section 101—Section 101 of Part A retains within the Department of Justice, under the direct authority of the Attorney General, a Law Enforcement Assistance Administration. The office is under the direction of an Administrator who reports to the Director of the Office of Justice Assistance, Research and Statistics established in Part H.

Section 102—Section 102 sets out the duties and functions of the Administrator.

Section 103—Section 103 retains within the Law Enforcement Assistance Administration the Office of Community Anti-Crime Programs. This office is authorized to encourage community and citizen participation in crime prevention, to coordinate its activities with ACTION and other Federal programs designed to increase citizen participation, and to provide grants and technical assistance for such purposes.

PART B—NATIONAL INSTITUTE OF JUSTICE

Sections 201 and 203—These sections establish within the Department of Justice, under the direct authority of the Attorney General, a National Institute of Justice. The Institute is to be headed by a Director who will report to the Director of the Office of Justice Assistance, Research and Statistics.

Section 202(c)—Section 202(c) sets out the authority of the Institute. This authority includes: (1) making grants and entering into cooperative agreements and contracts to conduct research, demonstrations, or special projects; (2) conducting or authorizing multi-year and short term research in civil, criminal, and juvenile justice systems; (3) conducting evaluations; (4) providing research fellowships and internships; (5) serving as a national and international clearinghouse; (6) serving in a consulting capacity to Federal, State, and local justice systems.

Section 202(d)—Section 202(d) sets out the functions and authority of the Director of the Institute.

Section 203—Section 203 provides that grants under Part B may be up to 100 per centum of the total cost of each project.

Section 204—Section 204 establishes a 21 member National Institute of Justice Advisory Board consisting of researchers, criminal justice practitioners, State and local elected officials, and members of the general public. The Board develops research policy for the National Institute of Justice.

PART C—BUREAU OF JUSTICE STATISTICS

Sections 301 and 302—Sections 301 and 302 establish within the Department of Justice, under the direct authority of the Attorney General, a Bureau of Justice Statistics. The Bureau is to be headed by a Director who will report to the Director of the Office of Justice Assistance, Research and Statistics.

Section 302(c)—Section 302(c) sets out the authority of the Bureau. This authority includes: (1) making grants and entering into cooperative agreements and contracts for the purpose of gathering justice statistics; (2) collecting and

ADD93

NEWS RELEASE - - -

PETER W. RODINO

10th District • New Jersey
Chairman
Committee on the Judiciary
U.S. House of Representatives

FOR IMMEDIATE RELEASE
THURSDAY, MAY 10, 1979, AND AFTER
CONTACT: JOHN NUSONELLO 202-225-3436

COMMITTEE APPROVES LEAA REORGANIZATION

WASHINGTON, D. C. -- The House Judiciary Committee, by a 24 to 6 vote, approved today a bill reorganizing the Law Enforcement Assistance Administration which places increased emphasis on anti-crime programs in local communities.

Rep. Peter W. Rodino, chairman of the committee and the bill's primary sponsor, said it "provides a significant improvement in LEAA's structure and organization, which will make it more effective in helping local governments fight crime."

He said the bill "offers an important balance in the areas of involvement for LEAA, while putting special emphasis on those areas which have proven most successful -- especially the Community Anti-Crime program."

"If we are ever to make real progress in reducing crime, we must encourage efforts by local citizens who are most familiar with the dangers and the causes of crime," he added.

The bill would require 10% of all LEAA funds to go for the Community Anti-Crime program which promotes crime prevention activities by non-governmental community groups.

The bill also provides a minimum of 20% of LEAA funds for juvenile delinquency programs with primary emphasis on serious juvenile offenders.

Rodino said "the bill is designed to drastically reduce the red tape which has plagued the process of getting federal assistance to states and local governments."

By requiring state and local governments to submit one application every three years instead of annually, the bill is expected to reduce paperwork by 60%.

The bill also would set up new "priority grants" which would provide extra money to programs that have proven especially effective in combatting crime.

A Bureau of Justice Statistics also would be established to collect and analyze information concerning crime, juvenile delinquency and the operation of the criminal justice system at various levels of government.

Rodino said he would "push very strongly for this bill's approval by the House because crime is a problem which concerns all of us -- and LEAA is the only instrument that the federal government has to assist states and localities to fight crime."

- 30 -

ADD94

FOR RELEASE SUNDAY
MAY 6, 1979, AND AFTER
CONTACT: JOHN RUSSONELLO 202-225-3436

RODINO LEADS FIGHT TO SAVE LEAA

WASHINGTON, D. C. -- Peter W. Rodino, Chairman of the House Judiciary Committee, is leading a fight to save the Law Enforcement Assistance Administration from drastic budget cuts in 1980.

Rodino has sent a letter to all House members asking them to vote against all amendments to the Fiscal 1980 Budget Resolution which would eliminate or reduce the amount Congress can authorize for LEAA in 1980.

"I am convinced that now is not the time to abandon LEAA, which is our last remaining federal commitment to the fight against street crime," Rodino said.

"I think that the recent climate to cut expenditures across-the-board can be irresponsible when you are considering vital programs," he added.

He pointed out that the \$546 million proposed by the 1980 budget resolution is a modest amount to spend for criminal justice assistance -- substantially below that appropriated for fiscal 1979."

He also added, "Crime continues to rank very high among the concerns of Americans, particularly those in our cities; yet less than one percent of the federal assistance that will be awarded to state and local governments next year will be allocated to LEAA under the 1980 budget resolution."

He promised to "make an all-out effort to save this program because I know how important it is to our states and localities. There must be a national commitment to fight crime, and if we abandon LEAA we will be turning our backs on the problem."

The House will be considering the 1980 budget resolution on Monday and Tuesday next week.

Rodino also announced that the House Judiciary Committee would begin on Tuesday marking up legislation to reorganize and restructure the LEAA.

"The committee's goal will be to allow the successful projects under LEAA to continue, while eliminating the less productive aspects of the program," Rodino said.

He noted that "the costs of more than 65% of the projects initially funded by LEAA are now financed by the participating communities or states."

Rodino is the principal sponsor of an LEAA reauthorization proposal in his committee, which he introduced for President Carter this year.

He said that the Judiciary Committee "must complete consideration of LEAA by May 15th according to the time limits established by the House budget process.

"If the House cuts the Budget authority for LEAA, it will tie the hands of the committee to decide the most constructive proposal to reorganize the agency.

"Crime is a national problem and LEAA is the only instrument that the federal government has to assist states and localities to fight crime."

95476

Federal Aid to Criminal Justice

Rhetoric, Results, Lessons

John K. Hudzik
Principal Author

with contributions by

Thomas J. Madden

and

Ernest E. Allen

Cornelius J. Behan

Geoff Gallas

Robert M. Morgenthau

Robert L. Smith

1984

The National Criminal Justice Association
Washington, D.C.

ADD96

14

the findings and recommendations were based on the most comprehensive review ever undertaken of the nature and causes of crime, of the performance and capability of the criminal justice system, and of the problems confronted by that system. Criticism was levelled not so much against the Commission's findings and conclusions as against its failure to offer concrete suggestions for meaningfully affecting crime in the near term.³⁴ This too would be addressed if not resolved in the debates surrounding passage of the Safe Streets Act in 1968.

Safe Streets: The Panoply of Conflicting Views

By 1967 reports of crime continued to paint an increasingly gloomy picture. Civil disorders of massive proportions engulfed several American cities during the summers of 1965, 1966, and 1967. Public ire and concern required a federal response greater than that made under provisions of the 1965 Law Enforcement Assistance Act. In response, President Johnson sent Congress a legislative message on crime (his third) that included a proposed bill entitled, "The Safe Streets and Crime Control Act of 1967." The President's message was delivered on February 6, 1967, and thirteen days later the President's Commission issued its long awaited report. The timing of the two events was not accidental, and the title of the President's bill was calculated to elicit maximum positive political response.

The Safe Streets Bill recognized the primacy of state and local police powers; all of its provisions were aimed at *assisting* the states in performing their functions rather than at taking over those functions or unduly interfering in the performance of them. Specific provisions included proposals of assistance to modernize equipment, to reorganize law enforcement agencies, to recruit and train law enforcement officers, to modernize the court system, to develop more effective rehabilitation techniques, and to set up effective crime-prevention programs. Even though several portions of the bill offered assistance to corrections and the courts, there was an apparently widespread assumption held in Congress as well as by the public that the assistance was primarily, if not exclusively, aimed toward law enforcement. Both the President's proposed legislation and the subsequent report of his Commission gave forthright recognition to the concept of a criminal justice system—an interrelated and interdependent group of "crime-fighting" agencies.

The Origins of LEAA.

15

Yet, during debate and passage of the legislation there was little to indicate that this concept received marked recognition or treatment.

The President's Safe Streets proposals were closely fashioned after the approach undertaken in the 1965 Law Enforcement Assistance Act. The grants would fund innovation and improvement in a variety of categories. Grant administration would be federally controlled under the Attorney General. There was much more money involved in the 1967 proposals, but the intent of grants-in-aid, as in the 1965 legislation, would be to make direct "categorical" grants. Cities with a population of fifty thousand or more (following the course laid out by other great-society funding ventures) would be eligible for action funds, but funding levels proposed were far smaller than those proposed for other great-society program efforts such as OEO.³⁵ This may have been a conscious effort to shield the crime proposals from the type of criticism then being levelled by Congress against OEO—namely, that OEO had gone in too fast with too much and had produced massive waste because the infrastructure was not available to manage the funds effectively.³⁶

Although the President's funding and program proposals were limited to innovation and improvement that were likely to have a significant effect on the crime problem only in the long run, the public and Congress were for quicker fixes. Part of this disparity can be traced to President Johnson himself: in 1965 he charged his Crime Commission to find the ways not only to reduce crime but to "banish" it.³⁷ Later attempts by the President to retreat from this excessive goal were too late—the public was fixed on the notion of quickly minimizing if not eliminating crime. The President's Commission in its final report did not help in setting expectations straight: at one point it asserted, "America can control crime."³⁸ The Commission noted that it would not be achieved quickly or easily, but few heard that. Among other factors involved, the nation was moving through a period of unbridled faith in the power of money and especially in the power of federal expenditures to solve problems.

Chapter 2 will treat the legislative debates and final features of the Safe Streets Act in greater detail. However, there are aspects to that debate and to the changes subsequently made to the President's proposal that reflect the several competing social and political forces discussed above. Clearly, the state's prerogatives in exercising the police power were hotly at issue. So, too, the get-tough preferences of conservatives, largely ignored in President Johnson's legislative proposals,

ADD97

The Origins of LEAA

- 21. Richard Harris, *The Fear of Crime*, (New York, Frederick A. Praeger, 1968), p. 10. Also see Walker, op. cit., p. 231.
- 27. Lyndon Johnson, *The Choices We Face* (New York: Bantam Books, 1969), p. 125.
- 28. See Caplan, op. cit., p. 386.
- 29. Walter B. Miller, "Ideology and Criminal Justice Policy: Some Current Issues," *Journal of Criminal Law and Criminology* 64, no. 2 (June, 1973), p. 141.
- 30. Caplan, op. cit., p. 590.
- 31. Hearings on S. 1792 and S. 1825 before a Subcommittee of the Senate Committee on the Judiciary, 89th Congress, 1st session (1965), p. 7.
- 32. Caplan, op. cit., pp. 593-594.
- 33. The President's Commission on Law Enforcement and Administration of Justice Report, op. cit., p. 15.
- 34. See, for example, James Q. Wilson, "A Reader's Guide to the Crime Commission Reports," *The Public Interest*, Fall, 1967, p. 65. Also see, Henry Rub, "To Dust Shall Ye Return!," *Norrie Dame Lawyer* 43 (1968), p. 811.
- 35. *The Budget in Brief*; Executive Office of the President, Bureau of the Budget, U.S. Government Printing Office. See these for the years 1965-1969.
- 36. Thomas E. Cronin, Tania Z. Cronin, and Michael E. Milakovich, *U.S. v. Crime in the Streets* (Bloomington: Indiana University Press, 1981), p. 32.
- 37. Public Papers of the Presidents of the United States, Lyndon B. Johnson, 1965 (1966) pp. 982-83.
- 38. The President's Commission on Law Enforcement and Administration of Justice, *The Challenge of Crime in a Free Society* (New York, Avon Books, 1968), p. 621.
- 39. Cronin, Cronin, and Milakovich, op. cit., pp. 50-53.
- 40. Law Enforcement Assistance Administration, Office of General Counsel, "Index to the Legislative History of the Omnibus Crime Control and Safe Streets Act of 1968," January 23, 1973, p. 117.
- 41. Cronin et al., op. cit., p. 51.
- 42. LEAA, Office of General Counsel, op. cit., p. 240.
- 43. *Ibid.*, p. 238.
- 44. Walker, op. cit., p. 237.

Chapter 2
LAWS AND REGULATIONS
GOVERNING THE LEAA PROGRAM

Thomas J. Madden

In the 1960s, Congress began to use the constitutional spending power to exert substantial policy controls over state and local functions and to create a host of new grant programs. In 1962, there were only 160 federal grant programs authorized by the Congress.¹ By January of 1967, when Congress prepared to take up the debate on the Safe Streets Act, the number of intergovernmental grant programs had grown to 379 with some 109 new grant programs being enacted in 1965 alone.² Federal assistance in dollar terms more than doubled between 1963 and 1967, rising from 7.7 percent to 11 percent of all federal budget outlays and from 1.5 percent to 2.2 percent of the gross national product.³

By 1967, it was also clear that the new programs and laws controlling the expenditure of the new grants⁴ had substantially altered the relationships between state, local, and federal government relationships without establishing an essential rationale for assigning intergovernmental functions other than that of pragmatic politics.⁵

The Safe Streets Act followed the pattern leading to the creation of many of these new programs. The rise in crime in 1963 and 1964 was the subject of debate in the 1964 elections and it was addressed by President Johnson in a crime message in 1965 calling for a national response to the crime problem.⁶ This message was followed by Congressional enactment of a small criminal justice assistance program and the appointment of the President's Commission on Law Enforcement and the Administration of Justice.⁷ The Commission documented the need for a major federal response to state and local crime problems, and Congress responded with the Omnibus Crime Control and Safe Streets Act.

When Congress took up the debate on President Johnson's proposal in 1967 to create a major new criminal justice assistance program, it quickly became clear that there were two issues of overriding concern to the conservative members who were in a position to control the

debate. The first was a concern that by vesting the Attorney General with the authority to provide grants to states, the Congress would also be giving the Attorney General the power to control state and local law enforcement agencies and would thereby be nationalizing state and local law enforcement functions. The second and related concern was that the Johnson proposal bypassed state government and allowed the Attorney General to deal directly with cities in making grants. In the view of then House Minority Leader Gerald R. Ford, a "direct" federalism approach would enable the Attorney General to "arbitrarily" decide which local law enforcement agencies would receive funds and what these agencies could do with the funds.⁸

The Senate Judiciary Committee was the initial focus of much of the concern over the creation of the national police force. The minority report of the committee, for example, in commenting on the discretionary authority given to the Attorney General to make grants stated:

[W]e don't want the Attorney General, the so-called "Mr. Big" of Federal law enforcement to become the director of State and local law enforcement as well. It is true that the Attorney General is the chief law enforcement officer of the Federal government. But he is not chief law enforcement officer of States and cities. We believe America does not want him to serve in that capacity. . . . We don't want this bill to become the vehicle for the imposition of Federal guidelines, controls, and domination.⁹

The House of Representatives, which acted first on the Johnson proposal, had accepted the view that the states should have control over expenditures by local government.¹⁰ This view was rejected by the Senate Judiciary Committee¹¹ and the Senate floor became the forum for the key debate on this issue. The contest was between the supporters of direct federalism—large city mayors and their Congressional supporters—and the supporters of state control through so-called block grants—governors from the Midwest and the Western states and Republican senators and southern Democratic senators.

Amendments to convert the Senate Committee bill from a direct local aid program to a state block grant program were introduced by Senate Minority Leader Everett M. Dirksen. Senator Dirksen contended that gubernatorial supervision over state planning was necessary to avoid duplication or conflict between local and state crime reduction plans and programs. In the debate he stated that:

We are never going to do a job in this field until we have a captain at the top, in the form of the Governor, and those he appoints, to coordinate the matter for a State because crime may be committed in a spot, but before it gets through its ramifications, it may spread over a very considerable area.¹²

The view stated by Senator Dirksen had roots not only in the Senator's traditional concern for state interests but also in the 1967 report of the President's Commission on Law Enforcement and the Administration of Justice, which recommended that:

In every State and every city, an agency, or one or more officials, should be specifically responsible for planning improvements in crime prevention and control and encouraging their implementation.¹³

The recommendation of the President's Crime Commission reflected a concern for system-wide planning. This meant at the very least *ad hoc* coordination among police, courts, and corrections agencies so that policies implemented in one part of the system would not have an adverse effect on other components.

The Dirksen amendments required each state to create a state criminal justice planning agency (SPA) and to develop an annual comprehensive plan. These amendments were intended, in part, to address the concerns of the President's Crime Commission. The amendments were also intended to assure that there was a coordinated intergovernmental approach to crime control in each state.

The block grant was also seen by its supporters as a way of minimizing substantive federal control over state and local law enforcement. In the Senate Judiciary Committee report on the Safe Streets Act, the supporters of block grants stated that the purpose of the block grant was "to insure that federal assistance to state and local law enforcement does not bring with it federal domination and control nor provide the machinery or potential for the establishment of a federal police force."¹⁴

The United States Court of Appeals for the Fourth Circuit in 1971 had an opportunity to comment on this latter concern of the block grant proponents. In a law suit challenging the lack of controls exerted over block grant expenditures, the court stated:

"The dominant concern of Congress apparently was to guard against any tendency towards federalization of local police and

"Federal Aid to Criminal Justice"

law enforcement agencies. Such a result, it was felt, would be less efficient than allowing local law enforcement officials to coordinate their state's overall efforts to meet unique local problems and conditions. Even more important than Congress's search for efficiency and expertise was its fear that over-broad federal control of state law enforcement would result in the creation of an Orwellian 'federal police force.'"¹⁵

The Senate passed the bill containing the Dirksen amendments by a 72 to 4 roll-call vote and final action on the legislation came on June 6, when the House accepted without change the Senate version.¹⁶ On June 19, 1968, President Johnson signed into law the Omnibus Crime Control and Safe Streets Act of 1968.¹⁷

A key assumption underlying the Safe Streets program was that, like many of the hundreds of new grant programs created by the Johnson Administration, "money makes a difference,"—that is, the more funds that are available, the greater the possibility of reducing crime.¹⁸

While the federal government had been extending nonfinancial criminal justice assistance to state and local governments at the operational level for several years prior to the enactment of the Safe Streets Act, the Act was the first major effort to provide financial assistance for state and local criminal justice efforts.¹⁹ The Safe Streets Act had three basic purposes:

- o the stimulation of efforts to improve the effectiveness of state and local criminal justice agencies;
- o the coordination of the activities of state and local criminal justice systems;
- o the upgrading of the capabilities of state and local criminal justice agencies to deal with crime.²⁰

The Safe Streets Act also gave the federal government new powers to enforce control over the sale and possession of handguns.²¹ It made possession of firearms by convicted felons a federal crime.²² It also made unauthorized wiretapping a federal crime.²³

Title I of the Safe Streets Act which established the LEAA program, had the following major provisions:

Administration. A Law Enforcement Assistance Administration (LEAA) was established within the Department of Justice. In doing so, Congress severely limited the authority of the Attorney

General over LEAA by establishing LEAA within the Department of Justice under the "general authority of the Attorney General." In essence, this meant that LEAA was to be free of the day-to-day supervision of the Attorney General to operate as an independent agency. LEAA was subject to the Attorney General's control only when the Attorney General established policies of general applicability to the entire Justice Department. The Attorney General did have final authority to recommend to the President and the Office of Management and Budget the amount of funds that should be appropriated each year for the LEAA programs.

The LEAA was put under the direction of a "troika"—an administrator and two associate administrators, appointed by the President, and confirmed by the Senate. The "troika" had authority jointly to carry out, the functions, powers and duties of the LEAA.

Block Grants. Block grants were authorized under Part B of the Act to cover up to 90 percent of the total cost of the operation of state planning agencies (SPAs), which were to be created or designated by the governor of each state and were to develop annual comprehensive criminal justice plans. The SPA was to have a representative character including representatives of law enforcement and units of local government. Each state was to be allocated each year a flat amount of \$100,000, with the remainder of planning funds to be distributed on a population basis. Forty percent of the planning grant funds were to be made available to local jurisdictions.

Under Part C of the Act, eighty-five percent of the so-called "action grant" funds were to be allocated to the states on a population basis as block grants, with seventy-five percent of the funds to be passed through to local governments. In order to receive a block action grant, the state had to submit a comprehensive plan that met certain requirements, including special emphasis on organized crime and civil disorder programs. The federal government was authorized to pay up to seventy-five percent of the total cost for organized-crime and riot-control projects, fifty percent for construction projects, and sixty percent for other action purposes. One significant limitation, added by those concerned about federal control of state and local law enforcement

ditions not found in the Safe Streets Act itself. Support for this proposition is claimed in the language and the policy inherent in the Safe Streets Act.

* * *

Reliance in the present case is misplaced, for it is plain that the LEAA has overdrawn the 'hands off' policy of the Safe Streets Act. Properly read, neither the Act's language nor its policy prohibits or excuses compliance with NHPA and NEPA.⁴⁹

In 1975 there were 19 different "cross-cutting" laws which governed the expenditure of federal grants which, under the rationale of the ruling in *Ely v. Velde*, neither prohibited nor excused compliance with these statutes. (Appendix II.)

In 1973, LEAA had undergone another reorganization which divided the state and local grant program among several offices within LEAA. (See Figure 6.)

The Juvenile Justice and Delinquency Prevention Act of 1974

By 1974, Congressional dissatisfaction with the low emphasis placed by LEAA on juvenile justice peaked. Congressional critics charged that LEAA's approach had been to see the juvenile offender in terms of crime and punishment. In their view, LEAA had not provided adequate funds for juvenile delinquency problems, particularly prevention, and had not succeeded in bringing about effective coordination of Federal juvenile delinquency programs.

Ultimately Congress passed the Juvenile Justice and Delinquency Prevention Act of 1974 and established an Office of Juvenile Justice and Delinquency Prevention in LEAA to administer it. The Senate Judiciary Committee stated that the purpose of the Act was as follows:

The Committee bill, as amended, provides for Federal leadership and coordination of the resources necessary to develop and implement at the State and local community level effective programs for the prevention and treatment of juvenile delinquency. Towards this end, it establishes a new Juvenile Justice and Delinquency Prevention program within the Department of Justice, Law Enforcement Assistance Administration, to provide comprehensive national leadership for attacking the problems of juvenile delinquency and to insure coordination of all delinquency activities of the Federal government.⁵⁰

44 "Federal Aid to Criminal Justice"

LEAA concluded that its block grants were not governed by these laws. In 1971 the courts held otherwise and by 1973 the adverse effects of the landmark decision in *Ely v. Velde*,⁴⁸ the first case to test the application of the block-grant concept to Federal strings, were being felt by states.

Ely v. Velde arose out of a block grant that LEAA made to the State of Virginia. In making the block grant, LEAA approved the comprehensive plan prepared by the State of Virginia in accordance with the Omnibus Crime Control and Safe Streets Act. The plan indicated that Virginia intended to spend approximately \$500,000 for a correctional facility. The expenditure of these funds was consistent with the Safe Streets Act. The plan did not specify where Virginia planned to build the facility.

At the time the Virginia plan was approved by LEAA, Virginia had not yet selected a final site. After the plan was approved, Virginia announced in a local newspaper that it intended to build a new penal facility in Green Springs, Virginia. Virginia did not notify LEAA of the selection of this site because it was not required by LEAA guidelines to do so.

Shortly after the announcement, a lawsuit was filed against the Administrator of LEAA and the Head of the Department of Corrections in Virginia. The lawsuit alleged that Virginia had failed to comply with the National Historic Preservation Act (NHPA) and the recently-enacted National Environmental Policy Act (NEPA) in selecting a site for the prison facility and that the Administrator of LEAA had failed to enforce NHPA and NEPA.

In their defense, LEAA and the State of Virginia contended that the LEAA program was a block-grant program and, under the LEAA law, the location for the penal facility was a state concern and not a Federal concern. LEAA contended that the State in expending LEAA funds did not have to comply with NEPA since the decision on where to build a penal facility was the state's decision and not subject to the review or disapproval of the Federal government. The district court agreed with this rationale and ruled against the plaintiffs.

The court of appeals disagreed and overruled the district court, making the following observation:

The LEAA insists that it is not obliged to comply—indeed it may not comply—with NHPA and NEPA because it has been disabled, when approving block grants, from imposing any con-

"Federal Aid to Criminal Justice"

Department of Treasury Circulars

- Treasury Circular 1075 Withdrawal of Cash from the Treasury for Advances Under Federal Grant and Other Programs
- Treasury Circular 1082 Notification to States of Grant-In-Aid Information

Executive Orders

- E.O. 11246 Nondiscrimination in Employment in Federally Assisted Construction Projects
- E.O. 11764 Nondiscrimination in Federally Assisted Programs
- E.O. 11914 Nondiscrimination with Respect to Handicapped in Federally Assisted Programs

APPENDIX II

STATUTES CONTROLLING EXPENDITURES OF GRANT FUNDS

ENVIRONMENTAL LAWS

1. National Environmental Policy Act of 1969, 42 U.S.C. § 4321, *et seq.* (1970) [NEPA]. NEPA requires Federal grantor agencies to consider the environmental impact of major Federal actions funded by Federal grants and to prepare environmental impact statements on these actions.
2. National Historic Preservation Act of 1966, 16 U.S.C. § 470, *et seq.* (1970) [NHPA]. NHPA requires Federal grantor agencies and grantees to consider the effect of Federally assisted projects on historical properties listed in the National Register of Historic Places.
3. Flood Disaster Protection Act of 1973, 42 U.S.C. § 4001, *et seq.* (Supp. II, 1973) [FDPA]. FDPA prohibits the use of Federal grant funds to support construction in any area identified by the Secretary of Housing and Urban Development as having special flood hazards unless the building and any related personal property is covered by flood insurance. *This is the only statute in this listing which exempts block grants from its coverage.*
4. Clean Air Act of 1970, 42 U.S.C. § 7401, *et seq.* (Supp. II, 1972). The Clean Air Act and Executive Order 11738 prohibit funding through grants of activities with an organization that proposes to use a facility which violates the air pollution standards of the Clean Air Act.
5. Federal Water Pollution Control Act of 1948, as amended, 33 U.S.C. § 1251, *et seq.* (Supp. II, 1972) [FWPCA]. The FWPCA and Executive Order 11738 prohibit funding through grants of activities with an organization that proposes to use a facility which violates the water pollution standards of the FWPCA.
6. Safe Drinking Water Act of 1974, 42 U.S.C. § 300f, *et seq.* (Supp. IV, 1974) [SDWA]. SDWA provides that no grant may be used to fund a project which may contaminate an aquifer which is the principal drinking water source for a community.
7. Endangered Species Act of 1973, 16 U.S.C. § 1531, *et seq.* (Supp. III, 1973) [ESA]. ESA requires Federal grantor agencies to assure that grant

Laws and Regulations Governing the LEAA Program

fund are not used in a manner that jeopardizes the continued existence of a threatened or endangered species.

8. Wild and Scenic Rivers Act of 1968, as amended, 16 U.S.C. § 1271, *et seq.* (1976) [WSRA]. WSRA requires Federal grantor agencies to assure that grant funds are not used in a manner that jeopardizes the clear and free-flowing condition of certain wild and scenic rivers.
9. Historical and Archeological Data Preservation Act of 1960, as amended, 16 U.S.C. § 489 *et seq.* (Supp. IV, 1974) [HADPA]. HADPA places limitations on the use of Federal funds to support an activity that may cause irreparable loss to significant historical or archeological data.
10. Coastal Zone Management Act of 1972, 16 U.S.C. § 1451, *et seq.* (Supp. II, 1972) [CZMA]. CZMA specifies that grant-supported activities must be consistent with State land-management programs for the protection of coastal zones, including Great Lake waters.

CIVIL RIGHTS LAWS

11. Title VI of the Civil Rights Act of 1964, 42 U.S.C. § 2000d (1970). Title VI provides that no person on the ground of race, color, or national origin can be excluded from participation in, be denied the benefits of, or be subjected to discrimination under any program or activity funded with Federal grants.
12. The Rehabilitation Act of 1973, 29 U.S.C. § 701, *et seq.* (Supp. III, 1973). The Rehabilitation Act extends the Title VI type protections to the handicapped.
13. Title IX of the Education Amendments of 1972, 20 U.S.C. § 1681 (Supp. II, 1972). Title IX provides that no person can on the basis of sex be excluded from participation in, be denied the benefits of, or be subjected to discrimination under any education program or project funded with Federal grants.

OTHER

14. Indian Self-Determination Act, 25 U.S.C. § 450f (Supp. V, 1975). The Self-Determination Act requires Federal grantor agencies to give preferences to training and employment of Indians and use of Indian enterprises for administrative functions under grant programs which benefit Indians.
- Intergovernmental Cooperation Act of 1968, 42 U.S.C. § 4201, *et seq.* (1970). The Intergovernmental Cooperation Act authorizes the creation of clearinghouses at the State and local levels to coordinate and review grant programs and projects. Use of the clearinghouse by Federal grantor agencies and State and local grantees is mandated by OMB Circular A-95.
16. Uniform Relocation Assistance and Real Property Acquisition Policies Act of 1970, 42 U.S.C. § 4801, *et seq.* (1970). The Relocation Act requires grantees to pay the costs of relocating individuals displaced by construction and leasing undertaken with Federal grant funds. It also requires grantees to assure that displaced persons find adequate housing.

17. Hatch Political Activity Act of 1940, as amended, 5 U.S.C. § 1501, *et seq.* (Supp. IV, 1974). The Hatch Act prohibits State and local government officials whose salaries are paid in part with Federal grant funds from running for political office other than the office they currently hold. It also prohibits coercion of political contributions from government employees whose salaries are paid with grant funds.
18. Animal Welfare Act of 1970, 7 U.S.C. § 2131, *et seq.* (1970). This Act requires research facilities to comply with humane standards for the care and handling of animals which are used in Federally-assisted projects or experiments.
19. Demonstration Cities and Metropolitan Development Act of 1966, 42 U.S.C. § 3301, *et seq.* (1970). This Act requires grantees to submit proposed metropolitan construction projects to an areawide planning agency for comments and recommendations prior to submitting a grant application to the Federal government.

Title 18 of the United States Code contains a number of criminal sanctions applicable to grants. These include prohibitions against false statements, 18 U.S.C. § 1001 (1970); prohibitions against using grants for political purposes, 18 U.S.C. §§ 600-607 (1970); and prohibitions against the expenditure of grant funds for purposes other than for which the funds were appropriated.

The listing does not include legislative riders attached to appropriation bills. It does not include acts such as the Davis Bacon Act, 40 U.S.C. § 2768 (1970), which are incorporated by specific statutory reference into the enabling statute of selected grant programs.

Chapter 3

LEAA IN THE STATES: 1968-1980

This chapter focuses on what happened to the LEAA program at the state level and particularly on the role played by the state planning agencies (SPAs). The lessons to be gained from the experience are rich but nonetheless complicated in what they offer to guide future criminal justice development. The chapter begins with a few remarks concerning our approach to assessment, and then examines the LEAA program in the states by following its evolution from 1968 to 1980. Employing the perspective provided by models of interorganizational and inter-governmental relations, the chapter ends with a preliminary assessment and analysis of the initial design and subsequent evolution of the program.

LEAA Program Objectives and an Approach to Assessment

The central objective of the Safe Streets Act was to build the capacity of state and local criminal justice agencies to combat crime. While the program enacted to achieve this effort was multifaceted, theynchpin was a group of programmatic and funding priorities directed toward three capacity-building initiatives at the state-level: (1) comprehensive system planning and coordination, (2) program innovation, and (3) development of new crime-fighting technology. State planning agencies were created to supply essential direction to these efforts.

A common assumption among proponents of the LEAA program had been that state and local units of government lacked both sufficient financial resources and policy commitment to support change in the criminal justice system.¹ The block grants were intended not only to offer the necessary financial support for innovation but were also intended to alter criminal justice agency task environments (that is, whom and what criminal justice agencies responded to, or more formally, the source and kind of inputs and the demand for outputs made by the criminal justice agency's relevant environment).² To alter agency task environments, new agencies, supported largely through LEAA funds, were to advance comprehensive planning, innovation, and co-

CONTROLLING CRIME THROUGH MORE EFFECTIVE LAW ENFORCEMENT

1833-1

HEARINGS
BEFORE THE
SUBCOMMITTEE ON
CRIMINAL LAWS AND PROCEDURES
OF THE
COMMITTEE ON THE JUDICIARY
UNITED STATES SENATE
NINETIETH CONGRESS

FIRST SESSION

ON

S. 300, S. 552, S. 580, S. 674, S. 675, S. 678,
S. 798, S. 824, S. 916, S. 917, S. 992, S. 1007,
S. 1094, S. 1194, S. 1333, and S. 2050

**BILLS RELATING TO CRIME SYNDICATES, WIRETAPPING,
ADMISSIBILITY IN EVIDENCE OF CONFESSIONS, ASSIST-
ING STATE AND LOCAL GOVERNMENTS IN COMBATING
CRIME AND RELATED AREAS OF CRIMINAL LAWS AND
PROCEDURES**

**MARCH 7, 8, AND 9; APRIL 18, 19, AND 20; MAY 9; JULY 10, 11, AND
12, 1967**

Printed for the use of the Committee on the Judiciary



U.S. GOVERNMENT PRINTING OFFICE
WASHINGTON: 1967

78-433

For sale by the Superintendent of Documents, U.S. Government Printing Office,
Washington, D.C. 20402 - Price \$3.50

ADD104

eral department or agency engaged in administering programs related to law enforcement and criminal justice shall, to the maximum extent practicable, consult with and seek advice from the Attorney General to insure fully coordinated efforts.

Sec. 404. The Attorney General may arrange with and reimburse the heads of other Federal departments and agencies for the performance of any of his functions under this Act, and, as necessary or appropriate, delegate any of his powers under this Act with respect to any part thereof; and authorize the redelegation of such powers.

Sec. 405. The Attorney General is authorized—

(a) to conduct research and evaluation studies with respect to matters related to this Act; and

(b) to collect, evaluate, publish, and disseminate statistics and other information on the condition and progress of law enforcement and criminal justice in the several States.

Sec. 406. Payments under this Act may be made in installments, and in advance or by way of reimbursement, as may be determined by the Attorney General.

Sec. 407. Whenever the Attorney General, after reasonable notice and opportunity for hearing to a grantee under this Act, finds that, with respect to any payments made under this Act, there is a substantial failure to comply with—

(a) the provisions of this Act;

(b) regulations promulgated by the Attorney General under this Act; or

(c) the law enforcement and criminal justice plan submitted in accordance with the provisions of this Act; the Attorney General shall notify such grantee that further payments shall not be made (or in his discretion that further payments shall not be made for activities in which there is such failure), until there is no longer such failure.

Sec. 408. Nothing contained in this Act shall be construed to authorize any department, agency, officer, or employee of the United States to exercise any direction, supervision, or control over any police force or other agency of any State or local law enforcement and criminal justice system.

Sec. 409. Unless otherwise specified in this Act, the Attorney General shall carry out the programs provided for in this Act during the fiscal year ending June 30, 1968, and the four succeeding fiscal years.

Sec. 410. Not more than 15 per centum of the sums appropriated or allocated for any fiscal year to carry out the purpose of this Act shall be used within any one State.

Sec. 411. The Attorney General, after appropriate consultation with representatives of State and local governments, is authorized to prescribe such regulations as may be necessary to implement the purpose of this Act, including regulations which—

(a) provide that a grantee will from time to time, but not less often than annually, submit a report evaluating accomplishments and cost-effectiveness of activities funded under this Act;

(b) provide for fiscal control, sound accounting procedures and periodic reports to the Attorney General regarding the application of funds paid under this Act; and

(c) establish criteria to achieve an equitable distribution among the States of assistance under this Act.

Sec. 412. On or before August 31, 1968, and each year thereafter, the Attorney General shall report to the President and to the Congress on activities pursuant to the provisions of this Act during the preceding fiscal year.

Sec. 418. For the purpose of carrying out this Act, there is hereby authorized to be appropriated the sum of \$50,000,000 for the fiscal year ending June 30, 1968; and for each succeeding fiscal year such sums as the Congress may hereafter appropriate. Funds appropriated for the purpose of carrying out this Act shall remain available until expended.

TITLE V—DEFINITIONS

Sec. 501. As used in this Act—

(a) "Law enforcement and criminal justice" means all activities pertaining to crime prevention or the enforcement and administration of the criminal law, including but not limited to activities involving police, prosecution or defense of criminal cases, courts, probation, corrections and parole;

CONTROLLING CRIME

383

course, the Governors often play a vital role in these functions. The attorneys general of the States have general supervision of all major criminal prosecutions and the trials. There is a very close supporting relationship between States and cities. For example, how can it be said that New York City is free and clear of State government and does not have any close ties or relationship in law enforcement. I cannot follow that reasoning.

Would you have a comment on this? It is not limited to New York, but, generally, I cannot see any difference between this field and any other fields.

Attorney General CLARK. I guess that police activities were the first function of cities if not of government itself. It has been a function we have left to the cities in this country. New York City provides an illustration. There are 28,000 policemen there. The annual budget of the New York City Police Department exceeds the budget of the U.S. Department of Justice by \$400 million. As far as I know the State does not provide any funds for police protection in New York City. They supply no advice. Only last year they established an office in the State government involving one man and one staff assistant. What can they contribute to the mighty police department of New York City, which has protected the people for generations.

As far as the powers of the State attorneys general are concerned, the average attorney general of a State exercises no significant criminal powers. Many have no legal authority in this area. Those that do have common law powers find it difficult to use them. A rare exception is the State of California where there is a department of justice but its functions, too, are limited. It tends to be on the prosecution side, rather than to involve police protection. And it exercises no control over the local district attorneys in their handling of prosecutions.

Senator HRUSKA. Your bill emphasizes that we are prosecutors of cases.

Attorney General CLARK. Yes.

Senator HRUSKA. Those claiming to be in the law enforcement part of justice make up a very small percentage.

Attorney General CLARK. Yes, very small.

Senator HRUSKA. In many of the Middle Western States the Attorney General prosecutes all appeals from trial courts and in many instances participates in the prosecution of cases and trials in State district courts.

Attorney General CLARK. There would be no need for a Governor veto there because he would be directly involved, presumably.

Senator HRUSKA. Of course, when we experience breakdown in a city police force due to either civil commotion or massive civil disobedience, the Governor steps in, does he not?

Attorney General CLARK. He has to sometimes, unfortunately.

Senator HRUSKA. In thinking of the Governor, I wonder if the fear of bypassing the State in a program of this kind would not grip the heart as much as other programs which they have discussed so vigorously.

Attorney General CLARK. My judgment is that it would not because police departments are old-line agencies with which the Governors have had a very minimal experience, connection, and relationship.

Senator HRUSKA. I do not know if you have convinced me. I just wanted to ascertain from you whether that had received any thought.

Such questioning is going to be raised on the Senate floor because there are many Governors who say you cannot be partners with the Federal Government.

The Federal Government is dealing out this money and after it becomes a substantial amount the municipality is hooked. If municipalities do not substantially comply with the plan, that money can be withdrawn and they have no alternative. They must run that department the way the Attorney General says they must, pursuant to that plan. Control then slips away from the municipality and goes into the Attorney General's Office.

Is that not about the size of it?

Attorney General CLARK. No. Not at all. That would be both a violation of the mandate and spirit of section 408. I think as a practical matter the Attorney General will not run the police department because they will not let him and because he does not want to. He would not even if he could do so.

And the amount of money contributed by the Federal Government will be a small fraction of the total investment and it could hardly be the controlling part.

Senator HRUSKA. You can go as high as 60 percent of those budgets for administrative improvement. The expenditure of 60 percent is a big percentage.

Attorney General CLARK. Sixty percent of the increase above 105 percent the first year, 110 percent the next year, 115 percent—

Senator HRUSKA. It is only to an improvement component which this 60 percent applies?

Attorney General CLARK. That is all.

Senator HRUSKA. Will it not in due time be a sizable amount?

Attorney General CLARK. It will become a large sum in some cases in due time.

Senator HRUSKA. Now you refer to section 408 which states that nothing contained in this act shall be construed to authorize any department, agency, officer, or employee of the United States to exercise any direction, supervision, or control over any police force or agency of any State or local law enforcement and criminal justice system.

That is a most noble statement made in good faith. Yet the preceding section says:

Whenever the Attorney General, after reasonable notice and opportunity for hearing to a grantee under this Act, finds that, with respect to any payments made under this Act, there is a substantial failure to comply with—

(a) the provisions of this Act—

And (b) and (c).

Considering the vast discretionary power invested in the Attorney General in this act and its overwhelming discretion in connection with this program, any aspect of the plan that has been submitted and approved must be OK'd by the Attorney General. Thus, if he feels it is being maladministered and not substantially complied with, he will say, "Sorry, boys, the show is over. No more money."

Would that constitute control and supervision in your judgment? It is well intended and filled with the spirit of wanting improved law enforcement service and all of its processes, but is it not a pretty compulsive situation?

Attorney General CLARK. No. I think it is necessary to the integrity of the act that its provisions be complied with and its regulations be

Attorney General CLARK. It can apply to any need of a police department or a corrections agency or a court.

Senator THURMOND. You have got a bill here then in which any police department of any city in this Nation can ask Washington, our Government, to help to supply uniforms and clothing to their policemen; is that right?

Attorney General CLARK. Well, that is a peculiar way of thinking about it. But they could come out that way. We require, however, that they have spent 105 percent before they are entitled to anything from the Federal Government. We would look at the whole budget together. Why in the world they would take out of all their budget uniforms and put it in the Federal part? Whether they could get the funds when they actually sought them for such a limited purpose or not is another question. But these funds would be available for any need of a police department that met the qualifications.

Senator THURMOND. Would that include shoes, too?

Attorney General CLARK. It could include shoes; yes.

Senator THURMOND. Well now, suppose the Federal Government said to the police departments over the country, suppose your director says, "Now, I think the policemen will look handsomer, better, and appear more disciplined if they all used blue uniforms and black shoes, and we are going to withhold funds unless you buy blue uniforms and black shoes."

Would your director have that authority to do that?

Attorney General CLARK. Well, I think we would start looking for a new director about that time.

Senator THURMOND. I know, but that is not the question. I am visualizing some Attorney General other than Mr. Clark now; someone who might succeed you some day and be arbitrary. Would your director have the right to withhold funds if the police departments did not use the color uniform he wanted or the color shoes or the quality of uniform or shoes that he wanted them to use?

Attorney General CLARK. He has to have broad discretion, and in theory he would probably have that discretion under the bill.

As a practical matter, the opportunity to exercise it would be very limited. The police are an independent type of person, and I just do not think that is a real possibility.

Senator THURMOND. But you think he would have that authority?

Attorney General CLARK. Yes, sir.

Senator THURMOND. Well, then, would your director also have the authority to say that, "We don't think a Colt is a very good pistol. It doesn't get results, and, therefore, we are not going to give any funds unless you buy Smith & Wesson pistols."

Would your director have the authority to withhold funds unless they used Smith & Wesson pistols?

Attorney General CLARK. I think if some police department sought Federal funds for a type of weapon that we thought was dangerous or unreliable or otherwise defective, that we would have a duty to withhold funds.

Senator THURMOND. So the Director would have the authority to withhold funds as to the kind of weapon or the quality of weapon that the city police department or the State law enforcement agency would purchase?

CONTROLLING CRIME

497

Attorney General CLARK. The probability of an exercise of discretion like that is very, very slight. It depends, unless—

Senator THURMOND. I am not saying how he would use this discretion, Mr. Attorney General. I am just asking, I am trying to get at the authority the bill gives, whether he would have the authority.

Attorney General CLARK. The bill gives broad discretion.

Senator THURMOND. It gives broad discretion.

Attorney General CLARK. Yes.

Senator THURMOND. So your director would have the right to withhold funds if he saw fit unless a policeman used the kind of weapons that he said they must use or use the kind of uniforms that he says they must use or use the kind of shoes that he said they must use.

Attorney General CLARK. No. I think that really is very remote. It is necessary under the bill to give broad discretion. But if it came to the specificity you are talking about, such an exercise of discretion would probably violate section 408 itself. It is so unreal.

Senator THURMOND. It is not contemplated, but is it possible?

Attorney General CLARK. I would say when it reaches the level that you have now reached with shoes and uniforms and guns and all these other things there would begin to be control of the police department, and there would be a violation of section 408 of the act, and, therefore, it would be in violation of the act.

Senator THURMOND. Well, I took up each one separately, and you said he would have the authority, and then I summarized it and lumped it together, and now you say you do not. What is your position?

Attorney General CLARK. My position is as stated that the case you pose would be clearly arbitrary, when you add them up the way you do—in fact, any one by itself would seem highly arbitrary to me and so unrealistic as to not be a possibility.

Senator THURMOND. Who is going to control whether he is arbitrary or not? He makes the final decision, does he not?

Attorney General CLARK. Well, there are lots of checks and balances that we have in the system, and one is we would hope he would always try to accomplish the purposes of the act, and if he proceeded the way you indicated, I think the act would break down.

Senator THURMOND. That is not the question. I asked you who would call his hand if he became arbitrary.

Attorney General CLARK. Well, perhaps, with you Senators up here, you would help and there would be an Attorney General and other people.

Senator THURMOND. That is not it. I mean in the executive branch. Suppose you had a director under you or some other Attorney General who was arbitrary, and he was trying to bring about conformity in every way, shape and form, just completely arbitrary. Now, who is above him to correct him?

Attorney General CLARK. We worked for these 19 months under the Law Enforcement Assistance Act. There is complete discretion in the director there. He can grant or not grant. There are no criteria or standards set whatever, and we have not had any complaints of any type that you raise.

Senator THURMOND. In other words, he does have the discretion but you do not think he would be arbitrary, is that it?

The amount of a mandatory grant is generally fixed by a “formula.” For that reason these grants are often called “mandatory state plan formula” grants.

§ 5.03(b) Requirements for the State Plan

The requirements for the state plan are generally quite lengthy and complex. They typically require the benefits of the grant to be passed on to the state’s residents in an evenhanded way. Various standards of this evenhandedness are spelled out in detail including often some degree of procedural protection for the intended indirect beneficiaries. The formulas for the grant payments take into account relevant factors, such as economic, social, and demographic data. They may have such variables as the population of the state, or the juvenile population, or the population residing in certain kinds of institutions. Grants for weatherization may have as parameters the number of “degree days” in an average year and the number of single family homes and their average square footage or cubic footage. The formula for Medicaid grants to the states under Title XIX of the Social Security Act fills more than a dozen pages of printing in the United States Code.⁴

Often, the state has been required to administer the grant through a single state agency, but this requirement may be waivable.⁵

§ 5.03(c) Formula Provisions

The amount of funds available is also typically set by a rather complex formula. A definition of formula grants given by the General Accounting Office reads: “Formula grants are grants in which a structured mathematical statement and data elements, such as statistical data, are used to (1) allocate funds to eligible recipients, or (2) determine a potential grant recipient’s eligibility to receive funds, or both.”⁶ For example, the amount may run to approxi-

⁴42 U.S.C. §§ 1396b, 1396d(b).

⁵31 U.S.C. § 6504.

⁶GAO, GRANT FORMULAS: A CATALOG OF FEDERAL AID TO STATES AND LOCALITIES at 10, GAO/HRO-87-28 (March 1987). The GAO report collects a large number of grant formulas. We discuss in Chapter 6 the Medicaid formula as a sample.

mately one-half to two-thirds of the total amount spent by the state for the grant purposes, but may include 100 percent reimbursement of certain expenditures, 90 percent of other expenditures, and 50 percent of others. The definition of expenditures that may be counted towards determining the federal share is also typically quite complex.

§ 5.03(d) Common Assurances for Mandatory Grants

An assurance that the federal government will not interfere in certain areas is frequently present. The areas typically protected are education, medicine, and police.⁷ Similar assurances are sometimes found in discretionary grant statutes as well.

§ 5.03(e) Flow-Through of Benefits

Although the state may be the grantee, the underlying purpose of the grant is typically to assist local governments through sub-awards by the state, or to assist the state's residents. Because of this, and perhaps, in part, because of some confusion of ideas, the ultimate intended beneficiary may be recognized as having rights, which the courts often approach in terms of constitutional doctrine.⁸

§ 5.04 CATEGORICAL GRANTS AND BLOCK GRANTS

There are grants that are classified as "categorical" grants, which can be contrasted with those classified as "block" grants.⁹

Grant programs that typically deal with assistance for fairly limited and specific purposes are often called "categorical" grants. Discretionary grants that may be for fairly limited purposes are also considered to be categorical.

In contrast, "block" grants are grants that are made to provide assistance within broad limits rather than for narrowly defined purposes. They authorize a broader range of activities. They are not categorical, since they deliberately leave the state a range of

⁷*Cf. Current Developments*, PUB. CONT. NEWSL. No. 2, at 16 (Jan. 1979). See § 4.09, *supra*.

⁸See, e.g., § 1.01(c), *supra*, and Chapter 7, "Mandatory Grants — The Town Court Case."

⁹§ 2.04(c), *supra*, and Chapter 8, "Block Grants."

11

Cross-Cutting Conditions

§ 11.01 DIFFERENCES AMONG GRANT CONDITIONS

A grant is normally accompanied by conditions. A major distinction among grant conditions is in the degree of generality. There are *government-wide* conditions, which apply nearly universally to all grant programs of all agencies. These are sometimes called “cross-cutting” conditions.¹ There are *agency-wide* conditions, sometimes called “general” conditions, which apply broadly to all grants of a certain type issued by a particular agency. There are *program* conditions, which are generally applicable to all grants under a particular grant program — these are most conveniently discussed along with agency-wide conditions. And there are *special* conditions, which are more or less tailored to problems perceived in a particular grant project. These different types of conditions will be discussed in turn.

§ 11.02 GOVERNMENT-WIDE CONDITIONS

Government-wide, or cross-cutting conditions, are largely imposed directly by statute. Some are imposed by Executive Order. A few are imposed by OMB circulars pursuant to statute. Others are imposed pursuant to OMB recommendation or other Executive Department policy advice, without statutory requirement.

The cross-cutting requirements are of two principal types:
a) socio-economic policy requirements — such as prohibition of

¹For a brief discussion of the history of the imposition and enforcement of conditions in grant programs, see P. Dembling & R. Dembling, *Significant Legislative Developments*, FEDERAL GRANT LAW 281, 294 *et seq.*, particularly § VI, “Cross-Cutting Conditions,” and n. 25 (ABA, M. Mason ed. 1982).

Termination? Refusal to refund for third grant year? Disallowance of costs involved? Other?

It is a fair question why, in the not-so-hypothetical case I have put, the second grant was made. Grantee's behavior on the first grant made it clear that grantee was a high-risk grantee. Why make grants to high-risk grantees? Carelessness? Sometimes. But often there is a better reason.

The basic goal of a grant program is to accomplish results, primarily the stimulation of local initiative, local creativeness, local sensitivity, local enthusiasm for programs that could not be accomplished or could not be accomplished well if carried out by a federal bureaucracy directly or by a contractor selected by the competition of an entrepreneurial world.

If you want that kind of enthusiasm, you must be prepared to accept the fact that creators and inventors are often not prudent businessmen and prudent businessmen often are not creative. You must often accept the fact that grantees undertaking such programs (primarily in the private sector) are specially created, special purpose organizations lacking financial stability apart from the grant, lacking fiscal and administrative experience but making up for it, you hope, in idealism, concern, innovation, freshness. Under certain circumstances nepotism can be consistent with idealism and concern. Grants are thus often made knowingly to grantees who represent a high risk, but a risk that is believed to be worthwhile in view of the importance of what it is hoped they will accomplish.²⁰

When grants are made to high-risk grantees, it is a responsibility of the grantor to apply appropriate restraints by special conditions, to provide special support and assistance where necessary and special monitoring where necessary.²¹

C. *How?*

Is the monitoring technique adequately defined? This does not mean defined with absolute precision, but in a manner reasonably intelligible to a reasonable grantee and reasonable program official or auditor or consultant. Are the standards reasonably defined? Where they are measurable, are the acceptable limits specified? In connection with standards, measurable standards are the easiest to deal with although they are not always the best. There is therefore a tendency to resort to the measurable even when it is not the best guide. To the extent that standards are subjective, is there a reasonable approximation to a standard that a professional in the appropriate discipline can apply? Sometimes

20. See, Mason, *Administration and Dispute Resolution*, *supra* note 4.

21. See Mason, *Administration and Dispute Resolution*, *supra* note 4; OMB Circular A-110, Para. 9; HEW GRANTS ADMINISTRATION MANUAL, 1-05-40C and—50 (High-Risk grantees).